



Profipress-Schiebemuffe mit SC-Contur

- Pressanschlüsse

Ausstattung

Dichtelemente EPDM

Modell 2415.3

Artikel 461 263

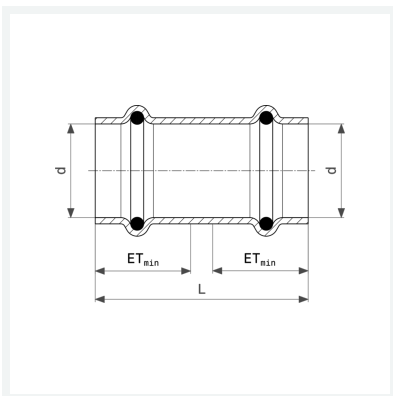

Eigenschaften

Rohraußendurchmesser	d	18
Länge	L	49 mm
Einstecktiefe minimal	ETmin	22 mm
Gewicht	42,3 g	
Volumen	82,88 cm ³	
Werkstoff	Kupfer	