

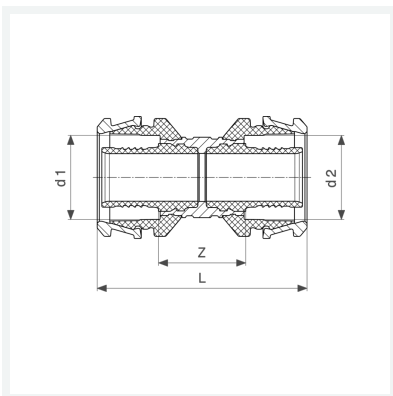

**Raxofix-Kupplung
mit SC-Contur**
- Pressanschluss
Modell 5315

Artikel 646 837



Eigenschaften

Rohraußendurchmesser 1	d1	25
Rohraußendurchmesser 2	d2	25
Z-Maß	Z	25 mm
Länge	L	64 mm
Gewicht	111,8 g	
Volumen	207,2 cm ³	
Werkstoff	Siliziumbronze	