



Röhrengeruchverschluss

Ausstattung

Verstellrohr 75 mm, Ablaufbogen 250 mm

güteüberwacht nach DIN EN 274

Modell 5611.917

Artikel 193 638

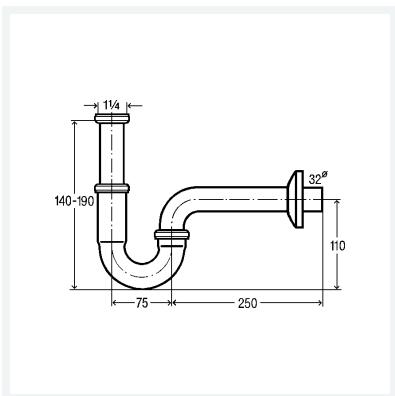

Eigenschaften

Gewinde zylindrisch	G	1 1/4
Durchmesser Nominal	DN	32
Gewicht	395 g	
Volumen	3044,065 cm ³	
Werkstoff	Messing verchromt	