



Reduziernippel

- R-Gewinde

Ausstattung

Mehrkant

Modell 3245

Artikel 266 523

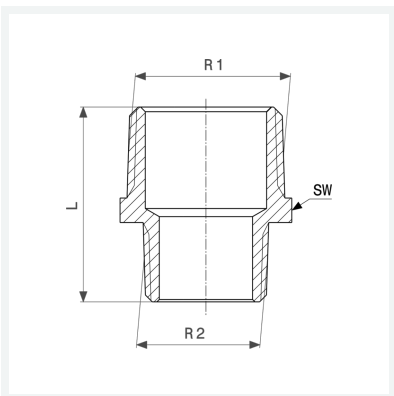

Eigenschaften

Außengewinde kegelig 1	R1	$\frac{3}{4}$
Außengewinde kegelig 2	R2	$\frac{1}{2}$
Länge	L	37 mm
Schlüsselweite	SW	27 mm
Gewicht	64,28 g	
Volumen	49,728 cm ³	
Werkstoff	Rotguss oder Siliziumbronze	