

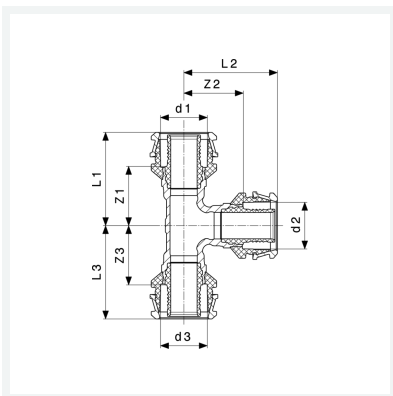

**Raxofix-T-Stück  
mit SC-Contur**  
- Pressanschlüsse  
**Modell 5318**

**Artikel 647 308**



## Eigenschaften

Rohraußendurchmesser 1	d1	20
Rohraußendurchmesser 2	d2	16
Rohraußendurchmesser 3	d3	16
Z-Maß 1	Z1	25 mm
Z-Maß 2	Z2	25 mm
Z-Maß 3	Z3	24 mm
Länge 1	L1	40 mm
Länge 2	L2	40 mm
Länge 3	L3	39 mm
Gewicht	89 g	



**Raxofix-T-Stück  
mit SC-Contur  
Modell 5318  
Artikel 647 308**

## Eigenschaften

---

Volumen	165,76 cm <sup>3</sup>
Werkstoff	Siliziumbronze