

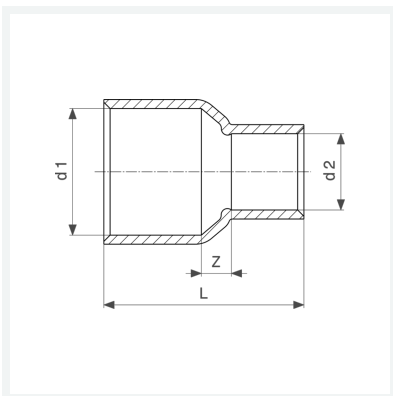

**Reduziermuffe**  
- Lötanschluss  
**Modell 95240**

**Artikel 117 269**



## Eigenschaften

Gütesicherung Cu	Cu	✓
Rohraußendurchmesser 1	d1	42
Rohraußendurchmesser 2	d2	28
Z-Maß	Z	13 mm
Länge	L	59 mm
Gewicht	91,8 g	
Volumen	177,6 cm <sup>3</sup>	
Werkstoff	Kupfer	