

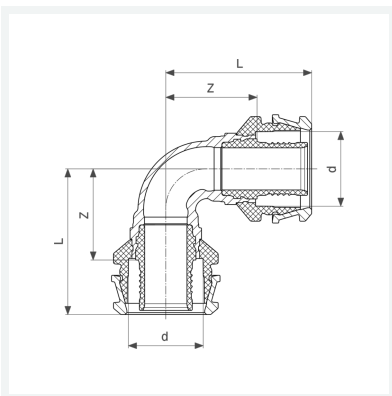

**Raxofix-Bogen 90°
mit SC-Contur**
- Pressanschluss
Modell 5316

Artikel 647 049



Eigenschaften

Rohraußendurchmesser	d	40
Z-Maß	Z	46 mm
Länge	L	73 mm
Gewicht	438 g	
Volumen	828,8 cm ³	
Werkstoff	Siliziumbronze	