

# INSTALLATION MANUAL

MONTAGEANLEITUNG  
INSTRUCTIONS DE MONTAGE  
ISTRUZIONI PER IL MONTAGGIO

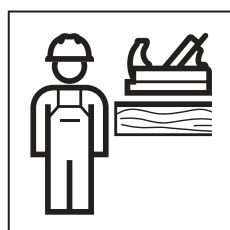

970.258.00.0(01)

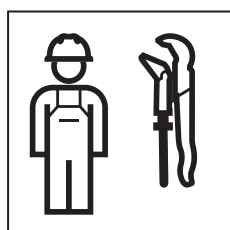



## **GEFAHR**

### **Unsachgemässe Montage**

Herabfallen des Produkts kann zu schweren Verletzungen führen.

- ▶ Vor der Montage die Tragfähigkeit der Wand prüfen.
- ▶ Vor der Montage prüfen, ob das mitgelieferte Befestigungsmaterial für den Wandtyp geeignet ist. Das Befestigungsmaterial bei Bedarf austauschen.



## **DANGER**

### **Incorrect installation**

If the product falls from a height it can lead to serious injuries.

- ▶ Check the bearing capacity of the wall before installation.
- ▶ Before installation, check whether the supplied fastening material is suitable for the type of wall in question. If necessary, replace the fastening material.



## **DANGER**

### **Montage inapproprié**

La chute du produit peut entraîner des blessures graves.

- ▶ Avant le montage, vérifier la portance de la paroi.
- ▶ Avant le montage, vérifier que le matériel de fixation convient au type de paroi. Au besoin, remplacer le matériel de fixation.



## **PERICOLO**

### **Montaggio inappropriato**

La caduta del prodotto può provocare gravi lesioni.

- ▶ Prima del montaggio, verificare la capacità portante della parete.
- ▶ Prima del montaggio, verificare se il materiale di fissaggio fornito in dotazione è adatto per il tipo di parete. All'occorrenza, sostituire il materiale di fissaggio.



## **GEVAAR**

### **Foutieve montage**

Het eraf vallen van het product kan tot ernstig letsel leiden.

- ▶ Vóór de montage het draagvermogen van de wand controleren.
- ▶ Vóór de montage controleren, of het meegeleverde bevestigingsmateriaal voor het wandtype geschikt is. Indien nodig het bevestigingsmateriaal vervangen.



## **PELIGRO**

### **Montaje inadecuado**

La caída del producto puede causar lesiones graves.

- ▶ Antes del montaje, comprobar la capacidad de carga de la pared.
- ▶ Antes del montaje, comprobar si el material de fijación suministrado es el adecuado para el tipo de pared en cuestión. En caso necesario, cambiar el material de fijación.



## **PERIGO**

### **Montagem incorreta**

A queda do produto pode causar ferimentos graves.

- ▶ Verificar a capacidade de carga da parede antes da montagem.
- ▶ Antes da montagem, verificar se o material de fixação fornecido é adequado para o tipo de parede. Se necessário, substituir o material de fixação.



## **FARE**

### **Forkert montering**

Hvis produktet falder ned, kan det føre til alvorlige kvæstelser.

- ▶ Kontroller væggens bæredygtighed inden monteringen.
- ▶ Kontroller inden monteringen, at det medfølgende fastgørelsesmateriale er egnet til vægtypen. Udskift fastgørelsesmaterialet ved behov.



## **FARE**

### **Feil montering**

Hvis produktet faller ned, kan det føre til alvorlige personskader.

- ▶ Kontroller bæreevnen til veggen før montering.
- ▶ Kontroller før montering om det medfølgende festematerialet egner seg for veggtypen. Bytt ut festematerialet ved behov.



## **FARA**

### **Felaktig montering**

Nedfallande produkt kan leda till allvarliga personskador.

- ▶ Kontrollera väggens hållfasthet före montering.
- ▶ Kontrollera före montering om det medföljande infästningsmaterialet är lämpat för väggtypen. Byt vid behov ut infästningsmaterialet.



## **VAARA**

### **Epäasianmukainen asennus**

Tuotteen putoamisesta voi aiheutua vakavia loukkaantumisia.

- ▶ Tarkasta seinän kantavuus ennen asentamista.
- ▶ Tarkasta ennen asentamista, sopiiko toimitettu kiinnitysmateriaali seinän tyyppiin. Vaihda kiinnitysmateriaali tarvittaessa.



## **HÆTTA**

### **Ekki farið rétt að við uppsetningu**

Ef varan fellur niður getur það valdið alvarlegum meiðslum.

- ▶ Kanna skal burðargetu veggs áður en uppsetning fer fram.
- ▶ Ganga skal úr skugga um að meðfylgjandi festibúnaður henti fyrir vegginn áður en uppsetning fer fram. Ef þörf krefur skal nota annan festibúnað.



## **NIEBEZPIECZEŃSTWO**

### **Nieprawidłowy montaż**

Spadnięcie produktu może prowadzić do ciężkich obrażeń.

- ▶ Przed montażem sprawdzić nośność ściany.
- ▶ Przed montażem sprawdzić, czy dostarczone elementy mocujące są przeznaczone do danego typu ściany. W razie potrzeby wymienić elementy mocujące.



## VESZÉLY

### Szakszerűtlen szerelés

A termék leesése súlyos sérüléseket okozhat.

- ▶ Felszerelés előtt ellenőrizze a fal tartóképességét.
- ▶ Felszerelés előtt ellenőrizze, hogy a mellékelt rögzítési anyag alkalmas-e az adott faltípushoz. Szükség esetén cserélje ki a rögzítési anyagot.



## NEBEZPEČENSTVO

### Neodborná montáž

Spadnutie výrobku môže viesť k ťažkým zraneniam.

- ▶ Pred montážou skontrolujte nosnosť steny.
- ▶ Pred montážou skontrolujte, či dodaný pripevňovací materiál je vhodný pre príslušný typ steny. V prípade potreby vymeňte pripevňovací materiál.



## NEBEZPEČÍ

### Neodborná montáž

Pád výrobku může způsobit těžké úrazy.

- ▶ Před montáží zkontrolujte nosnost stěny.
- ▶ Před montáží zkontrolujte, zda je dodaný upevňovací materiál vhodný pro daný typ stěny. V případě potřeby upevňovací materiál vyměňte.



## NEVARNOST

### Nestrokovna montaža

Padec izdelka lahko povzroči težke poškodbe.

- ▶ Pred montažo preverite nosilnost stene.
- ▶ Pred montažo preverite, ali je dobavljeni pritrdilni material primeren za tip stene. Pritrdilni material po potrebi zamenjajte.



## OPASNOST

### Nestručna montaža

Pad proizvoda može izazvati teške ozljede.

- ▶ Prije montaže provjerite nosivost zida.
- ▶ Prije montaže provjerite je li isporučeni pričvrtni materijal prikladan za tip zida. Po potrebi zamijenite pričvrtni materijal.



## OPASNOST

### Nepravilna montaža

Padanje proizvoda može da dovede do teških povreda.

- ▶ Pre montaže ispitati nosivost zida.
- ▶ Pre montaže ispitati da li je isporučeni materijal za pričvršćenje pogodan za tip zida. Materijal za pričvršćenje, po potrebi, zameniti.



## OHT

### Asjatundmatu paigaldus

Toote allakukkumine võib põhjustada raskeid vigastusi.

- ▶ Enne paigaldamist kontrollige seina kandevõimet.
- ▶ Enne paigaldamist kontrollige, kas kaasapandud kinnitusmaterjal sobib seina tüübiga. Vajadusel asendage kinnitusmaterjal.



## BĪSTAMI

### Nelietpratīga montāža

Produkta nokrišana var izraisīt smagas traumas.

- ▶ Pirms montāžas pārbaudiet sienas nestspēju.
- ▶ Pirms montāžas pārbaudiet, vai piegādes komplektā iekļautais stiprinājuma materiāls ir piemērots sienas tipam. Stiprinājuma materiālu nepieciešamības gadījumā nomainiet.



## PAVOJINGA

### Netinkamas montavimas

Nukritęs gaminys gali sukelti sunkius kūno sužalojimus.

- ▶ Prieš montavimą patikrinkite sienos atsparumą apkrovai.
- ▶ Prieš montavimą patikrinkite, ar patiekta tvirtinimo medžiaga pritaikyta sienos tipui. Jeigu būtina, tvirtinimo medžiagą pakeiskite.



## ОПАСНОСТ

### Неправилен монтаж

Падането на продукта може да причини тежки наранявания.

- ▶ Преди монтажа проверете товароносимостта на стената.
- ▶ Преди монтажа проверете дали доставените с продукта крепежни елементи са подходящи за типа стена. При необходимост сменете крепежните елементи.



## PERICOL

### Montaj incorect

Căderea produsului se poate solda cu leziuni grave.

- ▶ Înainte de montajul, verificați capacitatea portantă a peretelui.
- ▶ Înainte de montajul, verificați dacă materialul de fixare livrat este adecvat pentru tipul de perete respectiv. La nevoie, înlocuiți materialul de fixare.



## RREZIK

### Montimi i papërshtatshëm

Nëse produkti bie mund të shkaktojë lëndime të rënda.

- ▶ Para montimit kontrolloni aftësinë mbajtëse të murit.
- ▶ Para montimit kontrolloni, nëse materiali i fiksimit i dërguar bashkë me produktin është i përshtatshëm për llojin e murit. Nëse është e nevojshme ndryshoni materialin e fiksimit.



## ОПАСНОСТ

### Непрописна монтажа

Паѓањето на производот може да предизвика тешки повреди.

- ▶ Проверете ја носивоста на ѕидот пред монтажата.
- ▶ Проверете пред монтажата дали добиениот материјал за прицврстување е наменет за типот на ѕид. Заменете го материјалот за прицврстување по потреба.



## ΚΙΝΔΥΝΟΣ

### Λανθασμένη συναρμολόγηση

Η πτώση του προϊόντος μπορεί να οδηγήσει σε σοβαρούς τραυματισμούς.

- ▶ Πριν από τη συναρμολόγηση, ελέγξτε τη φέρουσα ικανότητα του τοίχου.
- ▶ Πριν από τη συναρμολόγηση, ελέγξτε αν το παρεχόμενο υλικό στερέωσης είναι κατάλληλο για τον συγκεκριμένο τύπο τοίχου. Εάν χρειάζεται, αντικαταστήστε το υλικό στερέωσης.



## TEHLİKE

### Hatalı montaj

Ürünün düşmesi ağır yaralanmalara yol açabilir.

- ▶ Montajdan önce duvarın taşıma kapasitesini kontrol edin.
- ▶ Montajdan önce, birlikte teslim edilen sabitleme malzemesinin duvar tipi için uygun olup olmadığını kontrol edin. Gerekirse sabitleme malzemesini değiştirin.



## ОПАСНО

### Неквалифицированный монтаж

Падение изделия может привести к получению тяжелых травм.

- ▶ Перед монтажом проверить несущую способность стены.
- ▶ Перед монтажом проверить, подходят ли входящие в комплект поставки крепежи к типу стены. При необходимости заменить крепежи .



## НЕБЕЗПЕЧНО

### Неналежний монтаж

Падіння виробу може спричинити тяжкі травми.

- ▶ Перед монтажем перевірити тримкість стіни.
- ▶ Перед монтажем перевірити, чи кріплення, що входить у комплект, придатне для наявного типу стіни. За потреби замінити кріплення.



## 危險

### 安装不当

产品坠落可能造成人员重伤。

- ▶ 安装前检查墙壁的承载能力。
- ▶ 安装前检查随附的紧固件是否适用于此类墙壁。必要时更换紧固件。



## خطر التركيب غير السليم

قد يؤدي سقوط المنتج إلى إصابات بالغة.

- ◀ تحقق من القدرة التحميلية للجدار قبل التركيب.
- ◀ تأكد قبل التركيب من أن مادة التثبيت المرفقة مناسبة لنوع الجدار. قم بتغيير مادة التثبيت إذا لزم الأمر.

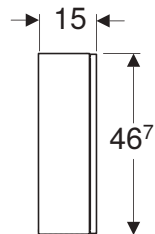
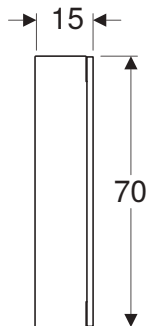
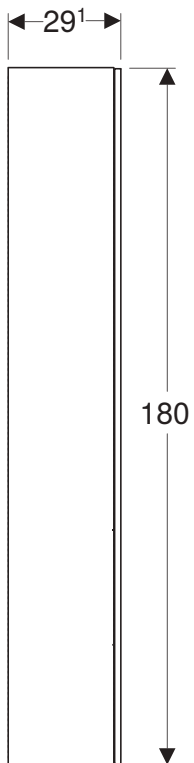
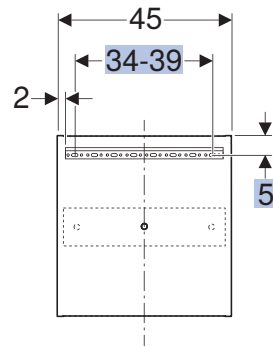
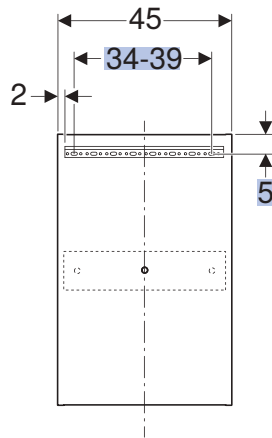
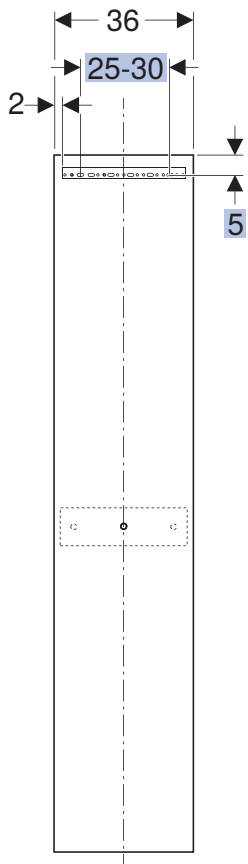

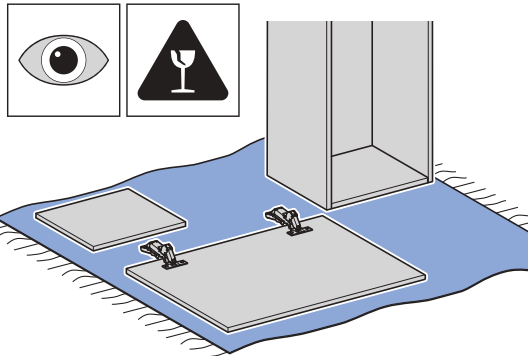

1

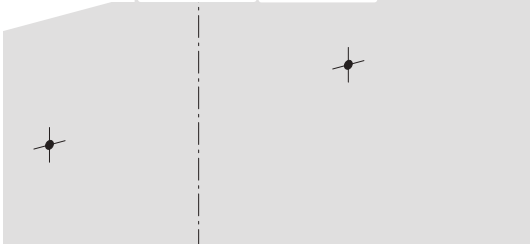
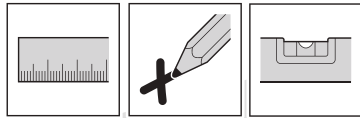

2

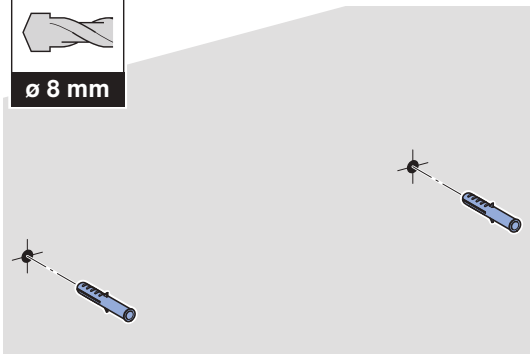
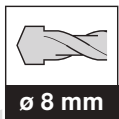

3

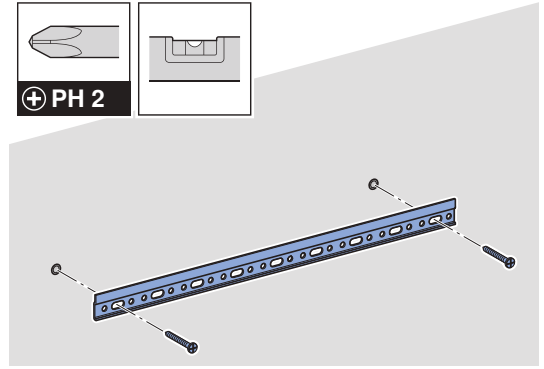
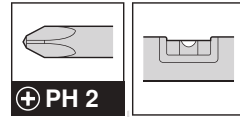

4

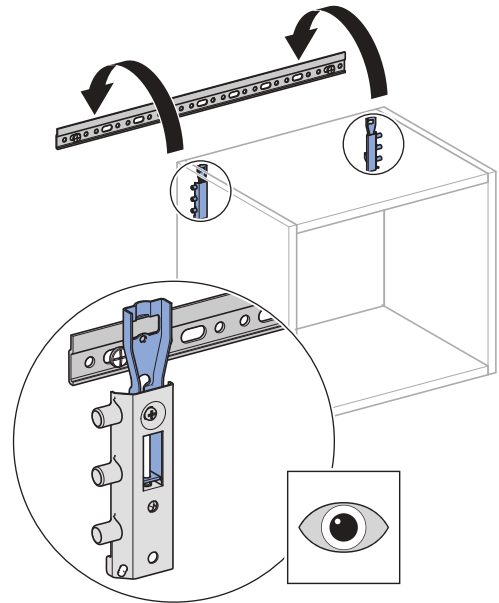

5

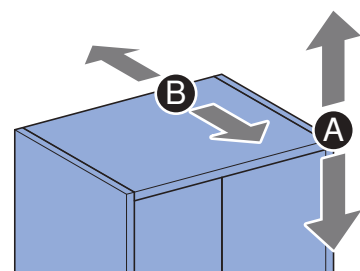
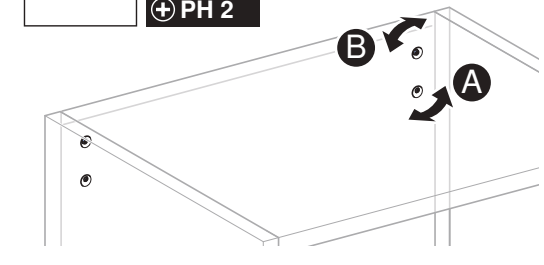
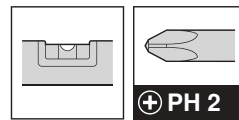



# 2

1

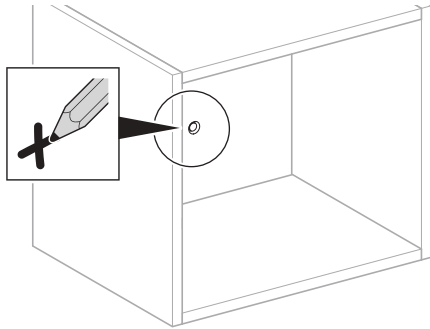

2

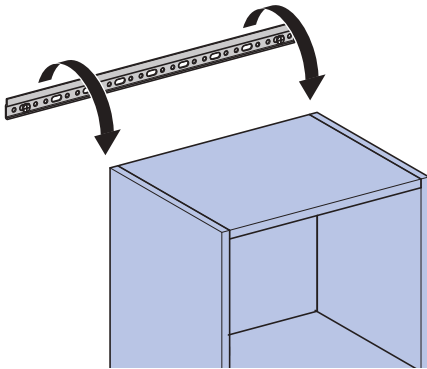

3

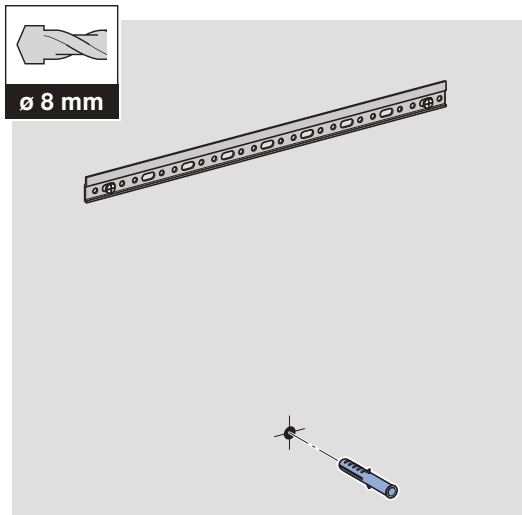

4

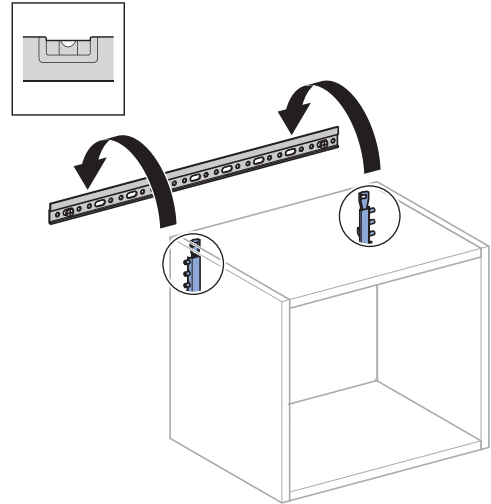

5

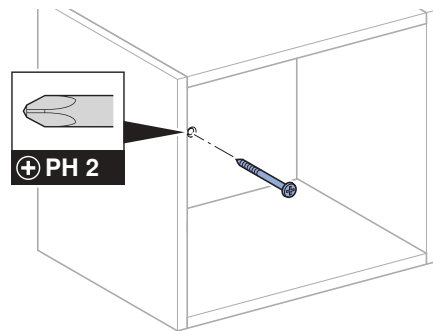

# 3

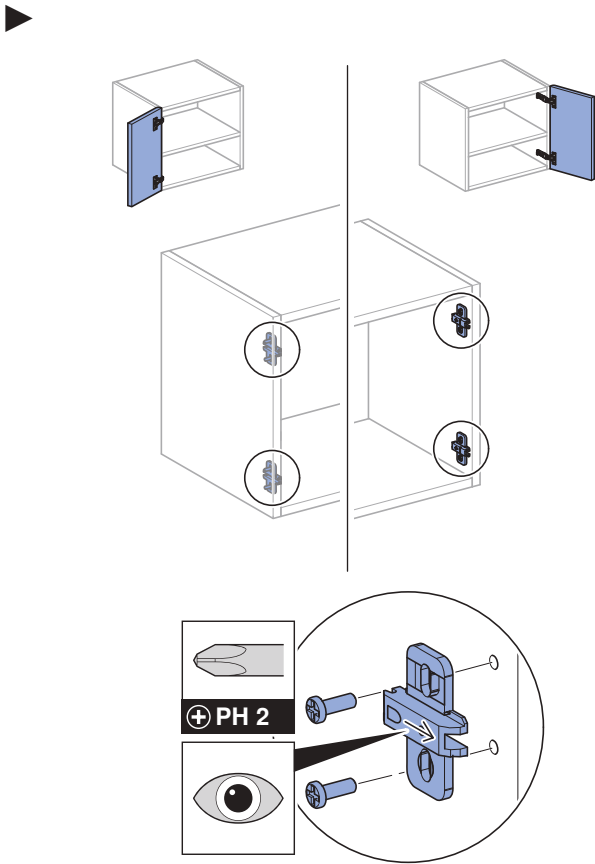

# 4

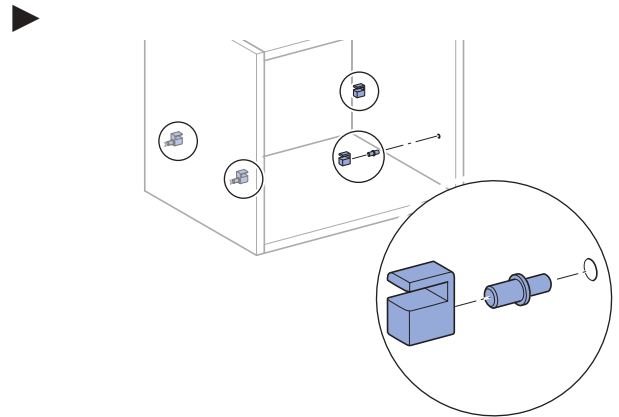

# 5

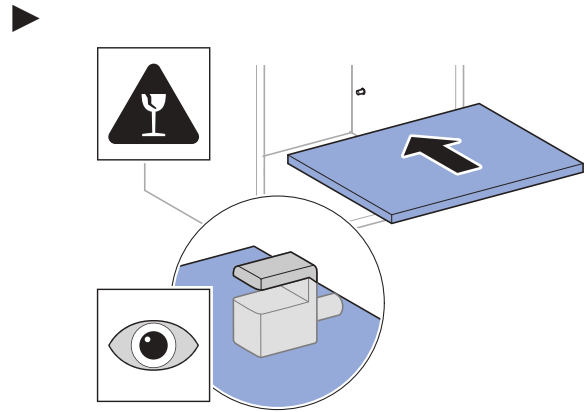

# 6

1

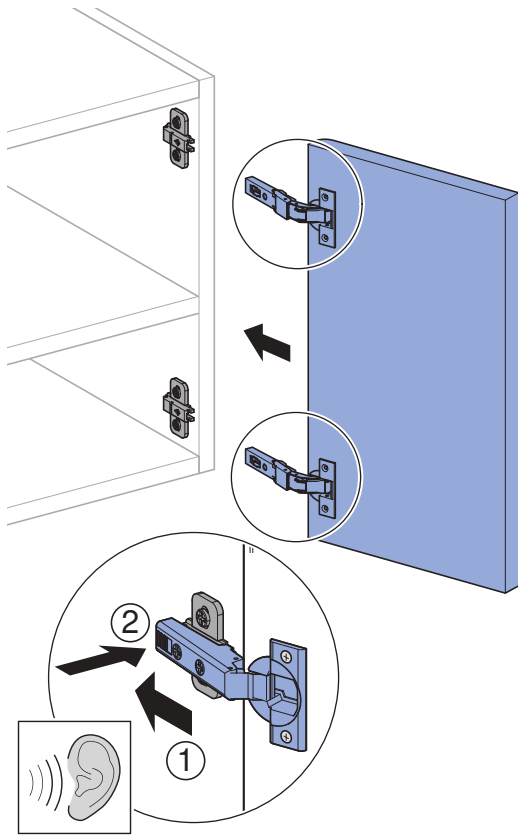

2

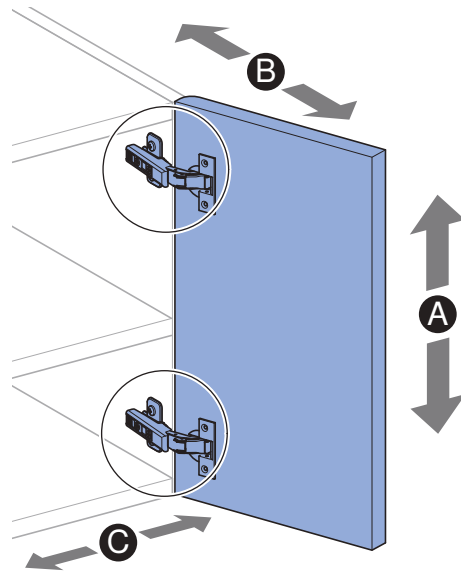
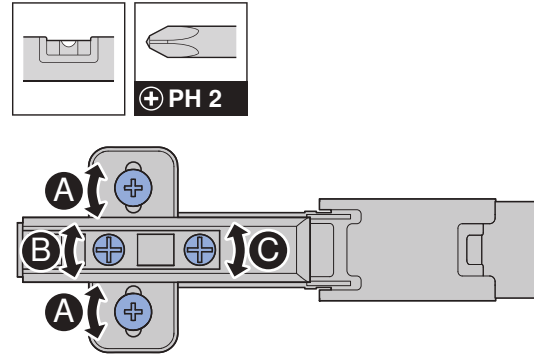

3

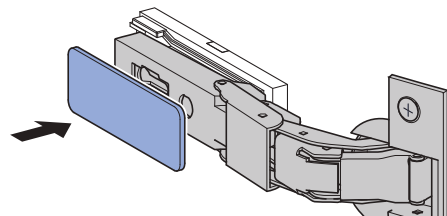

# 7

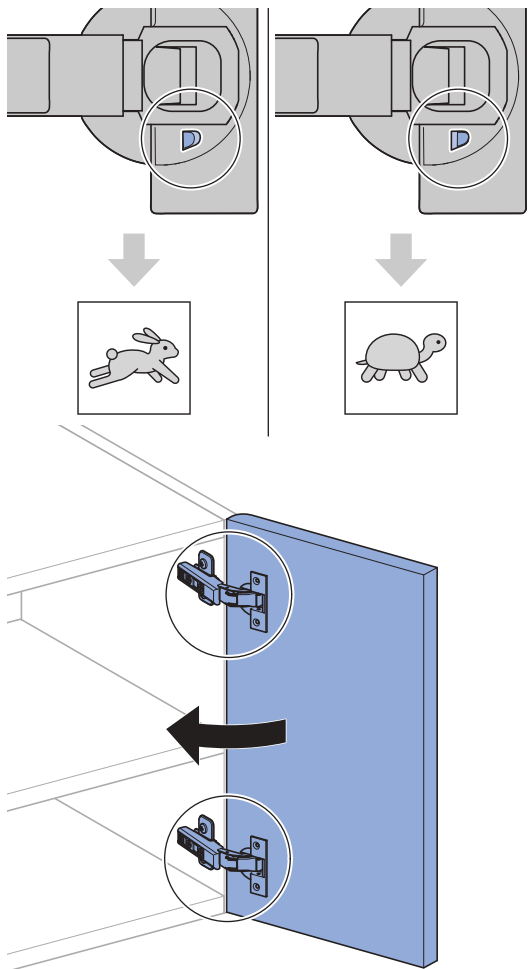

# i

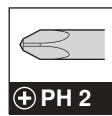

PH 2

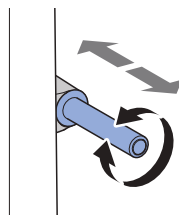
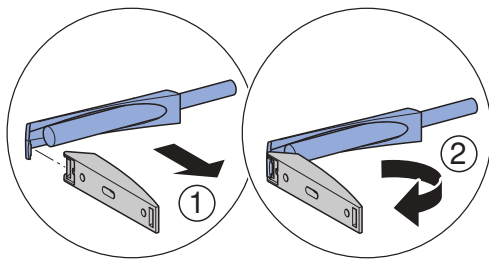
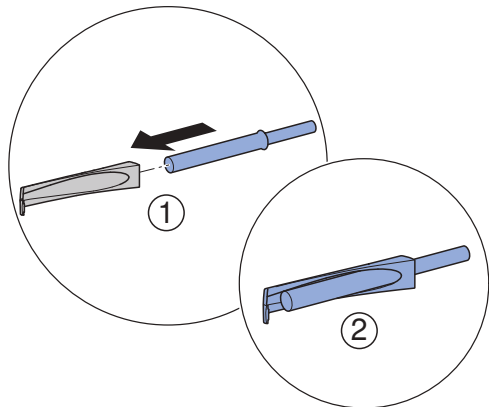
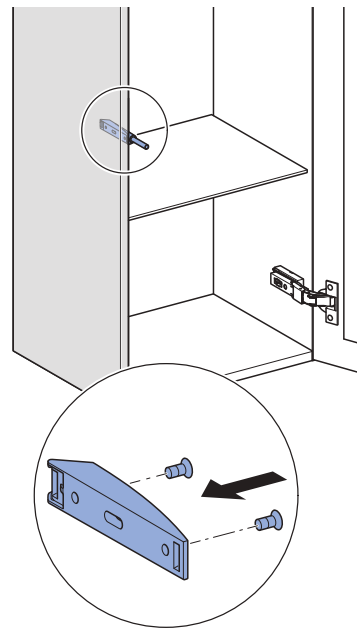

Geberit International AG  
Schachenstrasse 77, CH-8645 Jona  
documentation@geberit.com  
www.geberit.com

