

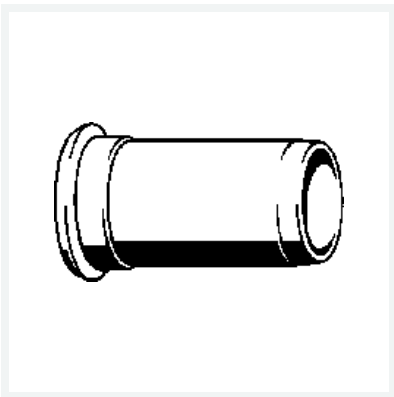

Maxiplex-Stützhülse
- für Maxiplex-Klemmverbinder, Wasseranwendung
Modell 9005

Artikel 275 495



Eigenschaften

Für Rohraußendurchmesser	für d	20
Gewicht	5,5 g	
Volumen	41,44 cm ³	
Werkstoff	PE	