

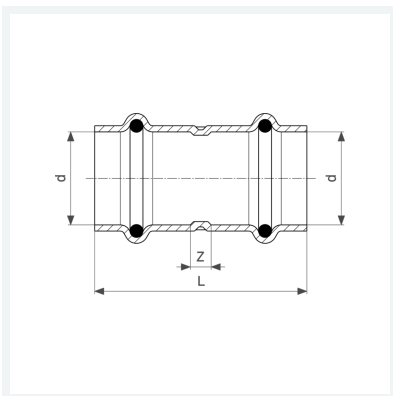

**Profipress-Muffe
mit SC-Contur**
- Pressanschlüsse
Ausstattung
Dichtelemente EPDM
Modell 2415

Artikel 292 706



Eigenschaften

VdS-Zulassung	VdS	✓
Rohraußendurchmesser	d	35
Z-Maß	Z	4 mm
Länge	L	56 mm
Gewicht	96 g	
Volumen	248,64 cm ³	
Werkstoff	Kupfer	