

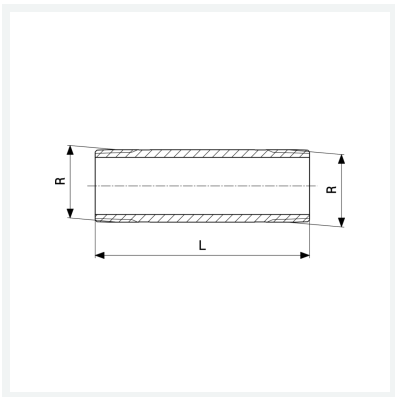

Langnippel
- R-Gewinde
Modell 3530

Artikel 267 278



Eigenschaften

Länge	L	100
Außengewinde kegelig	R	1
Länge	L	100 mm
Gewicht	284,2 g	
Volumen	248,64 cm ³	
Werkstoff	Rotguss oder Siliziumbronze	