

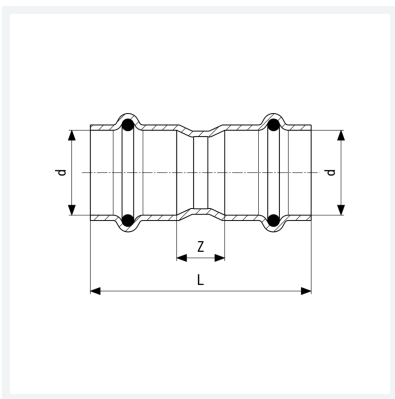

**Temponox-Muffe
mit SC-Contur**
- Pressanschlüsse
Ausstattung
Dichtelemente EPDM
Modell 1715

Artikel 808 983



Eigenschaften

Rohraußendurchmesser	d	18
Z-Maß	Z	11 mm
Länge	L	55 mm
Gewicht	40,9 g	
Volumen	82,88 cm ³	
Werkstoff	Stahl nichtrostend	