

DE	Gebrauchsanleitung / Montageanleitung	2
FR	Mode d'emploi / Instructions de montage	2
EN	Instructions for use / assembly instructions	3
IT	Istruzioni per l'uso / Istruzioni per Installazione	3
ES	Modo de empleo / Instrucciones de montaje	4
NL	Gebruiksaanwijzing / Handleiding	4
DK	Brugsanvisning / Monteringsvejledning	5
PT	Instruções para uso / Manual de Instalação	5
PL	Instrukcja obsługi / Instrukcja montażu	6
CS	Návod k použití / Montážní návod	6
SK	Návod na použitie / Montážny návod	7
ZH	用户手册 / 组装说明	7
RU	Руководство пользователя / Инструкция по монтажу	8
HU	Használati útmutató / Szerelési útmutató	8
FI	Käyttöohje / Asennusohje	9
SV	Bruksanvisning / Monteringsanvisning	9
LT	Vartotojo instrukcija / Montavimo instrukcijos	10
HR	Upute za uporabu / Uputstva za instalaciju	10
TR	Kullanım kılavuzu / Montaj kılavuzu	11
RO	Manual de utilizare / Instrucțiuni de montare	11
EL	Οδηγίες χρήσης / Οδηγία συναρμολόγησης	12
SL	Navodilo za uporabo / Navodila za montažo	12
ET	Kasutusjuhend / Paigaldusjuhend	13
LV	Lietošanas pamācība / Montāžas instrukcija	13
SR	Uputstvo za upotrebu / Uputstvo za montažu	14
NO	Bruksanvisning / Montasjeveiledning	14
BG	Инструкция за употреба / Ръководство за монтаж	15
SQ	Udhëzuesi i përdorimit / Udhëzime rreth montimit	15
AR	دليل الاستخدام / تعليمات التجميع	16

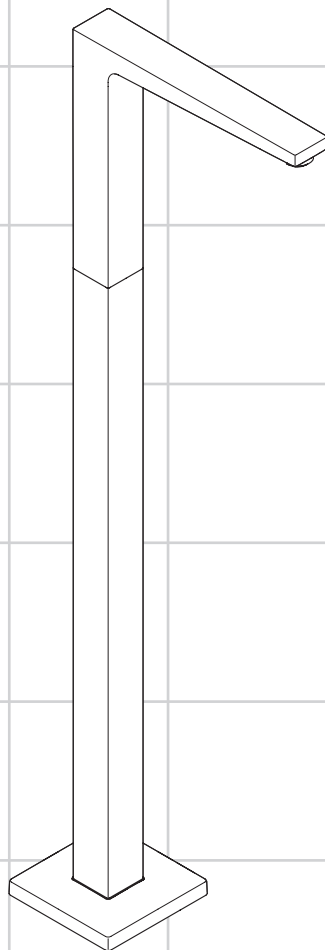

Metropol
32531000



! Sicherheitshinweise

- Bei der Montage müssen zur Vermeidung von Quetsch- und Schnittverletzungen Handschuhe getragen werden.
- Das Produkt darf nicht als Haltegriff benutzt werden. Es muss ein separater Haltegriff montiert werden.
- Das Produkt darf nur zu Bade-, Hygiene- und Körperreinigungszwecken eingesetzt werden.
- Große Druckunterschiede zwischen den Kalt- und Warmwasseranschlüssen müssen ausgeglichen werden.

Montagehinweise

- Vor der Montage muss das Produkt auf Transportschäden untersucht werden. Nach dem Einbau werden keine Transport- oder Oberflächenschäden anerkannt.
- Die Leitungen und die Armatur müssen nach den gültigen Normen montiert, gespült und geprüft werden.
- Die in den Ländern jeweils gültigen Installationsrichtlinien sind einzuhalten.

Symbolerklärung



Kein essigsäurehaltiges Silikon verwenden!



Maße (siehe Seite 19)



Durchflussdiagramm
(siehe Seite 19)



Serviceteile (siehe Seite 20)



Sonderzubehör (nicht im Lieferumfang enthalten)

Verlängerung 100 mm #97686000



Reinigung
siehe beiliegende Broschüre

! Consignes de sécurité

- Lors du montage, porter des gants de protection pour éviter toute blessure par écrasement ou coupure.
- Le produit ne doit pas servir de poignée. Monter pour cela une poignée séparée.
- Le produit ne doit servir qu'à se laver et à assurer l'hygiène corporelle.
- Il est conseillé d'équilibrer les pressions de l'eau chaude et froide.

Instructions pour le montage

- Avant son montage, s'assurer que le produit n'a subi aucun dommage pendant le transport. Après le montage, tout dommage de transport ou de surface ne pourra pas être reconnu.
- Les conduites et la robinetterie doivent être montés, rincés et contrôlés selon les normes en vigueur.
- Les directives d'installation en vigueur dans le pays concerné doivent être respectées.

Description du symbole



Ne pas utiliser de silicone contenant de l'acide acétique!



Dimensions (voir pages 19)



Diagramme du débit
(voir pages 19)



Pièces détachées (voir pages 20)



Accessoires en option (ne fait pas partie de la fourniture)

jeu de rallonge 100 mm #97686000







Nettoyage
voir la brochure ci-jointe





Safety Notes

-  Gloves should be worn during installation to prevent crushing and cutting injuries.
-  The product may not be used as a holding handle. A separate handle must be installed.
-  The product may only be used for bathing, hygienic and body cleaning purposes.
-  The hot and cold supplies must be of equal pressures.

Installation Instructions

- Prior to installation, inspect the product for transport damages. After it has been installed, no transport or surface damage will be honoured.
- The pipes and the fixture must be installed, flushed and tested as per the applicable standards.
- The plumbing codes applicable in the respective countries must be observed.

Symbol description



Do not use silicone containing acetic acid!



Dimensions (see page 19)



Flow diagram
(see page 19)



Spare parts (see page 20)







Special accessories (order as an extra)

extension 100 mm #97686000



Cleaning
see enclosed brochure

Indicazioni sulla sicurezza

-  Durante il montaggio, per evitare ferite da schiacciamento e da taglio bisogna indossare guanti protettivi.
-  Il prodotto non deve essere utilizzato come maniglia, questa deve essere montata separatamente.
-  Il prodotto deve essere utilizzato esclusivamente per fare il bagno e per l'igiene del corpo.
-  Attenzione! Compensare le differenze di pressione tra i collegamenti dell'acqua fredda e dell'acqua calda.

Istruzioni per il montaggio

- Prima del montaggio è necessario controllare che non ci siano stati danni durante il trasporto. Una volta eseguito il montaggio, non verranno riconosciuti eventuali danni di trasporto o delle superfici.
- Montare, lavare e controllare tubature e rubinetteria rispettando le norme correnti.
- Vanno rispettate le direttive di installazione nazionali vigenti nel rispettivo paese.

Descrizione simbolo



Non utilizzare silicone contenente acido acetico!



Ingombri (vedi pagg. 19)



Diagramma flusso
(vedi pagg. 19)



Parti di ricambio (vedi pagg. 20)



Accessori speciali (non contenuto nel volume di fornitura)

Prolunga 100 mm #97686000



Pulitura
vedi il prospetto chiuso

Assembly
see page 17



Montaggio
vedi pagg. 17



⚠ Indicaciones de seguridad

- ⚠ Durante el montaje deben utilizarse guantes para evitar heridas por aplastamiento o corte.
- ⚠ El producto no debe ser utilizado como un elemento de sujeción. Debe montarse un elemento de sujeción separado.
- ⚠ El producto solo debe ser utilizado para fines de baño, higiene y limpieza corporal.
- ⚠ Grandes diferencias de presión en servicio entre agua fría y agua caliente deben equilibrarse.

Indicaciones para el montaje

- Antes del montaje se debe examinarse el producto contra daños de transporte. Después de la instalación no se reconoce ningún daño de transporte o de superficie.
- Los conductos y la grifería deben montarse, lavarse y comprobarse según las normas vigentes.
- Es obligatorio el cumplimiento de las directrices de instalación vigentes en el país respectivo.

Descripción de símbolos



No utilizar silicona que contiene ácido acético!



Dimensiones (ver página 19)



Diagrama de circulación
(ver página 19)



Repuestos (ver página 20)



Opcional (no incluido en el suministro)

Prolongación 100 mm #97686000



Limpiar
ver el folleto adjunto

⚠ Veiligheidsinstructies

- ⚠ Bij de montage moeten ter voorkoming van knel- en snijwonden handschoenen worden gedragen.
- ⚠ Het product mag niet als handgreep worden gebruikt. Er moet een aparte handgreep gemonteerd worden.
- ⚠ Het product mag alleen voor het wassen, hygiënische doeleinden en voor de lichaamreiniging worden gebruikt.
- ⚠ Grote drukverschillen tussen de koud- en warmwatertoevoer dienen vermeden te worden.

Montage-instructies

- Vóór de montage moet het product gecontroleerd worden op transportschade. Na de inbouw wordt geen transport- of oppervlakteschade meer aanvaard.
- De leidingen en armaturen moeten gemonteerd, gespoeld en gecontroleerd worden volgens de geldige normen.
- De in de overeenkomstige landen geldende installatierichtlijnen moeten nageleefd worden.

Symboolbeschrijving



Gebruik geen zuurhoudende silicone!



Maten (zie blz. 19)



Doorstroomdiagram
(zie blz. 19)



Service onderdelen (zie blz. 20)



Toebehoren (behoort niet tot het leveringspakket)

Verlengstuk 100 mm #97686000



Reinigen
zie bijgevoegde brochure





Montaje
ver página 17



Montage
zie blz. 17





Sikkerhedsanvisninger

-  Ved monteringen skal der bruges handsker for at undgå kvæstelser og snitsår.
-  Produktet må ikke bruges som håndtag. Der skal monteres et separat håndtag.
-  Produktet må kun bruges til bade-, hygiejne og kropsrengøringsformål.
-  Større trykforskelle mellem koldt og varmt vand bør undgåes.





Monteringsanvisninger

- Før monteringen skal produktet kontrolleres for transportskader. Efter monteringen godkendes transportskader eller skader på overfladen ikke længere.
- Ledningerne og armaturerne skal monteres, skylles og kontrolleres iht. de gældende standarder.
- Installationsbestemmelserne, der gælder i det enkelte land, skal overholdes.

Symbolbeskrivelse

-  Der må ikke benyttes eddikesyreholdig silikone!
-  **Målene** (se s. 19)
-  **Gennemstrømningsdiagram** (se s. 19)
-  **Reserve dele** (se s. 20)
-  **Specialtilbehør** (ikke med i leveringsomfang)
Forlængersæt 100 mm #97686000
-  **Rengøring**
se venligst den vedlagte brochure







Avisos de segurança

-  Durante a montagem devem ser utilizadas luvas de protecção, de modo a evitar ferimentos resultantes de entalamentos e de cortes.
-  O produto não pode ser utilizado como pega de apoio. Tem que ser montada uma pega separada.
-  O produto só pode ser utilizado para fins de higiene pessoal.
-  Grandes diferenças entre as pressões das águas quente e fria devem ser compensadas.

Avisos de montagem

- Antes da montagem deve-se controlar o produto relativamente a danos de transporte. Após a montagem não são aceites quaisquer danos de transporte ou de superfície.
- As tubagens e a torneira têm que ser montadas, enxaguadas e verificadas de acordo com as normas em vigor.
- A prescrições de instalação válidas nos respetivos países devem ser respeitadas.





Descrição do símbolo

-  Não utilizar silicone que contenha ácido acético!
-  **Medidas** (ver página 19)
-  **Fluxograma** (ver página 19)
-  **Peças de substituição** (ver página 20)
-  **Acessórios especiais** (não incluído no volume de fornecimento)
Crescente 100 mm #97686000
-  **Limpeza**
consultar a seguinte brochura





Wskazówki bezpieczeństwa

-  Aby uniknąć zranień na skutek zgniecenia lub przecięcia, podczas montażu należy nosić rękawice ochronne.
-  Produktu nie wolno używać jako uchwytu do trzymania się. Należy zamontować osobny uchwyt.
-  Produkt może być używany tylko do kąpieli, higieny i czyszczenia ciała.
-  Znaczne różnice ciśnień na doptywach ciepłej i zimnej wody muszą zostać wyrównane.

Wskazówki montażowe

- Przed montażem należy skontrolować produkt pod kątem szkód transportowych. Po montażu nie widać żadnych szkód transportowych ani szkód na powierzchni.
- Przewody i armatura muszą być montowane, płukane i kontrolowane według obowiązujących norm.
- Należy przestrzegać wytycznych instalacyjnych obowiązujących w danym kraju.

Opis symbolu



Nie stosować silikonów zawierających kwas octowy!



Wymiary (patrz strona 19)



Schemat przepływu

(patrz strona 19)



Części serwisowe (patrz strona 20)



Wyposażenie specjalne (Nie jest częścią dostawy)





Przedłużka 100 mm #97686000



Czyszczenie

patrz dołączona broszura

Bezpečnostní pokyny

-  Pro zabránění řezným zraněním a pohmožděním je nutné při montáži nosit rukavice.
-  Produkt nesmí být používán jako madlo. Je nutné namontovat samostatné madlo.
-  Produkt smí být používán pouze ke koupání a za účelem tělesné hygieny.
-  Je nutné vyrovnat velké rozdíly tlaku mezi přípoji studené a teplé vody.

Pokyny k montáži

- Před montáží je třeba produkt zkontrolovat, zda nebyl při transportu poškozen. Po zabudování nebudou uznány žádné škody způsobené transportem nebo poškození povrchu.
- Vedení a armatura musí být namontovány, propláchnuty a otestovány podle platných norem.
- Je třeba dodržovat montážní pravidla platné v dané zemi.

Popis symbolů



Nepoužívat silikon s obsahem kyseliny octové!



Rozměry (viz strana 19)



Diagram průtoku

(viz strana 19)



Servisní díly (viz strana 20)



Zvláštní příslušenství (není součástí dodávky)

prodloužení 100 mm #97686000



Čištění

viz přiložená brožura





⚠ Bezpečnostné pokyny

- ⚠ Pri montáži musíte nosiť rukavice, aby ste predišli pomliaždeninám a rezným poraneniam.
- ⚠ Výrobok sa nesmie používať ako držadlo. K tomu účelu sa musí namontovať samostatné držadlo.
- ⚠ Produkt sa smie používať len na kúpanie a telesnú hygienu.
- ⚠ Veľké rozdiely v tlaku medzi prípojkami studenej a teplej vody musia byť vyrovnané.

Pokyny pre montáž

- Pred montážou musíte produkt skontrolovať, či nebol počas transportu poškodený. Po zabudovaní nebudú uznané žiadne škody spôsobené transportom alebo poškodenia povrchu.
- Ledningarna och blandaren måste monteras, spolás igenom och kontrolleras enligt de gällande normerna.
- Je potrebné dodržiavať smernice o inštalácii, ktoré sú práve teraz platné v krajinách.

Popis symbolov

 Nepoužívať silikón s obsahom kyseliny octovej!

 **Rozmery** (viď strana 19)

 **Diagram prietoku**
(viď strana 19)

 **Servisné diely** (viď strana 20)

 **Zvláštne príslušenstvo** (nie je súčasťou dodávky)

Predĺženie 100 mm #97686000

 **Čistenie**
nájdete v priloženej brožúre

⚠ 安全技巧

- ⚠ 装配时为避免挤压和切割受伤，必须戴上手套。
- ⚠ 该产品不得作扶柄使用。必须安装单独的扶柄。
- ⚠ 本产品只允许作为洗浴、卫生和洁身之用。
- ⚠ 冷热水管间过大的压力差必须予以平衡。

安装提示

- 安装前必须检查产品是否受到运输损害。安装后将不认可运输损害或表面损伤。
- 管道和阀门必须根据通用标准进行安装、冲洗和检查。
- 请遵守当地国家现行的安装规定。

符号说明

 请勿使用含有乙酸的硅胶！

 大小 (参见第页 19)

 **流量示意图**
(参见第页 19)

 备用零件 (参见第页 20)

 **选装附件** (不在供货范围内)
加长件100 mm #97686000

 **清洗**
附有小手册

Montáž
vid' strana 17



安装
参见第页 17

**⚠ Указания по технике безопасности**

- ⚠ Во время монтажа следует надеть перчатки во избежание прищемления и порезов.
- ⚠ Изделие запрещается использовать в качестве рукоятки. Следует устанавливать специальную рукоятку.
- ⚠ Изделие разрешается использовать только в гигиенических целях: для принятия ванны и личной гигиены.
- ⚠ донного клапа. Перед установкой смесителя необходимо регулировочными кранами выровнять давление холодной и горячей воды при помощи вентилей регулирующих подачу воды в квартиру.

Указания по монтажу

- Перед монтажом следует проверить изделие на предмет повреждений при перевозке. После монтажа претензии о возмещении ущерба за повреждения при перевозке или повреждения поверхностей не принимаются.
- Трубы и арматура должны быть установлены, промыты и проверены в соответствии с действующими нормами.
- Необходимо соблюдать требования по монтажу, действующие в соответствующих странах.

Описание символов

Не применяйте силикон, содержащий уксусную кислоту.



Размеры (см. стр. 19)



Схема потока
(см. стр. 19)



Комплект (см. стр. 20)



Специальные принадлежности (не включено в объем поставки!)

Удлинение 100 мм #97686000



Очистка
см прилагаемая брошюра

⚠ Biztonsági utasítások

- ⚠ A szerelésnél a zúzódások és vágási sérülések elkerülése érdekében kesztyűt kell viselni.
- ⚠ A terméket nem szabad kapaszkodónak használni. Ehhez külön kapaszkodót kell felszerelni.
- ⚠ A terméket csak fürdéshez, mosakodáshoz, és egészségügyi tisztálkodáshoz szabad használni.
- ⚠ A hidegvíz- és a melegvíz-csatlakozások közötti nagy nyomáskülönbséget kikell egyenlíteni!

Szerelési utasítások

- A szerelés előtt ellenőrizni kell, hogy a terméknek nincs-e szállítási sérülése. Beépítés után a szállítási- vagy felületi sérüléseket nem ismerik el.
- A vezetékeket és a csaptelepet az érvényes szabványoknak megfelelően kell felszerelni, öblíteni és ellenőrizni
- Az egyes országokban érvényes installációs irányelveket be kell tartani.

Szimbólumok leírása

Ne használjon ecetsavtartalmú szilikont!



Méretet (lásd a oldalon 19)



Átfolyási diagramm
(lásd a oldalon 19)



Tartozékok (lásd a oldalon 20)



Egyéb tartozék (a szállítási egység nem tartalmazza)

Hosszabbítás 100 mm #97686000



Tisztítás
lásd a mellékelt brosúrát





! Turvallisuusohjeet

- △ Asennuksessa on käytettävä käsiineitä puristumien ja viiltojen aiheuttamien tapaturmien estämiseksi.
- △ Tuotetta ei saa käyttää kädensijana. On asennettava erillinen kädensija.
- △ Tuotetta saa käyttää ainoastaan kylpy-, hygienia- ja puhdistustarkoituksiin.
- △ Suuret paine-erot kylmä- ja kuumavesiliitännöiden välillä on tasattava.

Asennusohjeet

- Ennen asennusta on tarkastettava tuotteen mahdolliset kuljetusvahingot. Asennuksen jälkeen kuljetus- ja pintaaurioita ei hyväksytä.
- Putket ja hana on asennettava, huuhdeltava ja tarkastettava voimassa olevien standardien mukaisesti.
- Jokaisessa maassa on noudatettava siellä päteviä asennusohjeita.

Merkin kuvaus

 Älä käytä etikahappopitoista silikoniala!

 **Mitat** (katso sivu 19)

 **Virtausdiagrammi**
(katso sivu 19)

 **Varaosat** (katso sivu 20)

 **Erytisvaruste** (ei kuulu toimitukseen)

Pidennys 100 mm #97686000

 **Puhdistus**
katso oheinen esite

! Säkerhetsanvisningar

- △ Handskar ska bäras under monteringsarbetet så att man kan undvika kläm- och skärskadorgen werden.
- △ Produkten får inte användas som handtag. Ett separat handtag måste monteras.
- △ Produkten får bara användas till kroppshygien med bad och dusch.
- △ Stora tryckskillnader mellan anslutningarna för varmt och kallt vatten måste utjämnas.

Monteringsanvisningar

- Det måste undersökas om produkten har transportskador innan den monteras. Efter monteringen accepteras inga transport- eller ytskiktsskador.
- Ledningarna och blandaren måste monteras, spolats igenom och kontrolleras enligt de gällande normerna.
- De installationsriktlinjer som gäller i länderna ska följas.

Symbolförklaring

 Använd inte silikon som innehåller ättiksyra!

 **Måtten** (se sidan 19)

 **Flödesschema**
(se sidan 19)

 **Reservdelar** (se sidan 20)

 **Specialtillbehör** (medföljer ej leveransen)

Förlängning 100 mm #97686000

 **Rengöring**
se den medföljande broschyren

Asennus
katso sivu 17



Montering
se sidan 17



Saugumo technikos nurodymai

- △ Apsaugai nuo užspaudimo ir įsijovimo montavimo metu mūvėkite pirštines.
- △ Gaminys neturi būti naudojamas kaip rankena. Rankena montuojama atskirai.
- △ Gaminys turi būti naudojamas tik maudymuisi, kūno higienai ir švarai palaikyti.
- △ Turi būti išlyginti šalto ir karšto slėgio nelygumai.

Montavimo instrukcija

- Prieš montuojant būtina patikrinti, ar gaminys nebuvo pažeistas transportavimo metu. Sumontavus pretenzijos dėl transportavimo ir paviršiaus pažeidimų nepriimamos.
- Vamzdžiai ir sujungimai turi būti montuojami, plaunami ir tikrinami pagal galiojančias normas.
- Laikykitės atitinkamoje šalyje galiojančių direktyvų dėl įrengimo.

Simbolio aprašymas



Nenaudokite silikono, kurio sudėtyje yra acto rūgšties!



Išmatavimai (žr. psl. 19)



Pralaidumo diagrama (žr. psl. 19)



Atsarginės dalys (žr. psl. 20)



Specialūs priedai (nėra pridedama)

Ilgiklis 100 mm #97686000



Valymas

žr. pridedamoje brošiūroje

Sigurnosne upute

- △ Prilikom montaže se radi sprječavanja prignječenja i posjekotina moraju nositi rukavice.
- △ Proizvod ne smije služiti za pridržavanje. U tu se svrhu mora postaviti zaseban rukohvat.
- △ Proizvod se smije primjenjivati samo za kupanje, tuširanje i osobnu higijenu.
- △ Velika razlika u pritisku između vruće i hladne vode mora biti izbalansirana.

Upute za montažu

- Prije montaže mora se provjeriti je li proizvod oštećen prilikom transporta. Nakon ugradnje se ne priznaju nikakve reklamacije koje se odnose na površinska i transportna oštećenja.
- Cijevi i armatura moraju biti postavljeni, isprani i testirani prema važećim normama.
- Obvezno se moraju uvažiti propisi o instalacijama koji vrijede u dotičnoj zemlji.

Opis simbola



Nemojte koristiti silikon koji sadrži octenu kiselinu!



Mjere (pogledaj stranicu 19)



Dijagram protoka (pogledaj stranicu 19)



Rezervni djelovi (pogledaj stranicu 20)



Posebni pribor (Nije sadržano u isporuci!)

Produljenje 100 mm #97686000



Čišćenje

se u priloženoj brošiuri

Montavimas
žr. psl. 17



Sastavljanje
pogledaj stranicu 17



⚠ Güvenlik uyarıları

- ⚠ Montaj esnasında ezilme ve kesilme gibi yaralanmaları önlemek için eldiven kullanılmalıdır.
- ⚠ Ürün tutma kolu olarak kullanılmamalıdır. Aynı bir tutma kolu monte edilmelidir.
- ⚠ Ürün yalnızca banyo, hijyen ve beden temizliği amaçları doğrultusunda kullanılabilir.
- ⚠ Sıcak ve soğuk su bağlantıları arasında büyük basınç farklılıkları varsa, bu basınç farklılıklarının dengelenmesi gerekir.

Montaj açıklamaları

- Montaj işleminden önce ürün nakliye hasarları yönünden kontrol edilmelidir. Montaj işleminden sonra nakliye veya yüzey hasarları için sorumluluk üstlenilmemektedir.
- Boruların ve armatürün montajı, yıkanması ve kontrolü geçerli normlara göre yapılmalıdır.
- Ülkelerde geçerli kurulum yönetmeliklerine riayet edilmelidir.

Simge açıklaması



Asetik asit içeren silikon kullanmayın!



Ölçüleri (bakınız sayfa 19)



Akış diyagramı
(bakınız sayfa 19)



Yedek Parçalar (bakınız sayfa 20)



Özel aksesuarlar (Teslimat kapsamına dahil değildir)

Uzatma 100 mm #97686000



Temizleme
birlikte verilen broşür

⚠ Instrucțiuni de siguranță

- ⚠ La montare utilizați mănuișă pentru evitarea contuziunilor și tăierii mâinilor.
- ⚠ Nu este permisă utilizarea produsului pe post de mâner. este nevoie de montarea unui mâner corespunzător.
- ⚠ Produsul poate fi utilizat doar pentru spălarea, menținerea igienei și curățarea corpului.
- ⚠ Diferențele de presiune mari între alimentarea cu apă rece și apă caldă trebuie echilibrate.

Instrucțiuni de montare

- Înainte de instalare verificați, dacă produsul prezintă deteriorări de transport. După instalare garanția nu acoperă deteriorările de transport și cele de suprafață.
- Conducele și bateriile trebuie montate, spălate și verificate conform normelor în vigoare.
- Respectați reglementările referitoare la instalare valabile în țara respectivă.

Descrierea simbolurilor



Nu utilizați silicon cu conținut de acid acetic!



Dimensiuni (vezi pag. 19)



Diagrama de debit
(vezi pag. 19)



Piese de schimb (vezi pag. 20)



Accesorii opționale (nu este inclus în setul livrat)

Prelungitor 100 mm #97686000



Curățare
vezi broșura alăturată

Montajı
bakınız sayfa 17



Montare
vezi pag. 17

**⚠ Υποδείξεις ασφαλείας**

- ⚠ Για να αποφύγετε τραυματισμούς κατά τη συναρμολόγηση πρέπει να φοράτε γάντια.
- ⚠ Το προϊόν δεν επιτρέπεται να χρησιμοποιείται σαν λαβή στήριξης. Για τον σκοπό αυτό πρέπει να τοποθετηθεί ξεχωριστή λαβή στήριξης.
- ⚠ Το προϊόν επιτρέπεται να χρησιμοποιείται μόνο σαν μέσο λουτρού, υγιεινής και καθαρισμού του σώματος.
- ⚠ Οι διαφορές της πίεσης μεταξύ της σύνδεσης κρύου και ζεστού νερού θα πρέπει να αντισταθμίζονται.

Οδηγίες συναρμολόγησης

- Πριν τη συναρμολόγηση πρέπει να εξεταστεί το προϊόν για ζημιές μεταφοράς. Μετά την εγκατάσταση δεν αναγνωρίζονται ζημιές από τη μεταφορά ή επιφανειακές ζημιές.
- Οι σωλήνες και η μπαταρία πρέπει να τοποθετηθούν σύμφωνα με τα ισχύοντα πρότυπα, να τεθούν υπό πίεση και να δοκιμαστούν.
- Θα πρέπει να τηρούνται οι οδηγίες εγκατάστασης που ισχύουν σε κάθε κράτος.

Περιγραφή συμβόλων

Μην χρησιμοποιείτε σιλικόνη που περιέχει οξικό οξύ!



Διαστάσεις (βλ. Σελίδα 19)



Διάγραμμα ροής
(βλ. Σελίδα 19)



Ανταλλακτικά (βλ. Σελίδα 20)



Ειδικά αξεσουάρ (δεν περιλαμβάνεται στον παραδοτέο εξοπλισμό)

Σωλήνας επιμήκυνσης 100 mm #97686000



Καθαρισμός

βλ. συνημμένο φυλλάδιο

⚠ Varnostna opozorila

- ⚠ Pri montaži je treba nositi rokavice, da se preprečijo poškodbe zaradi zmečkanja ali urezov.
- ⚠ Proizvoda ne smete uporabljati kot držalnega ročaja. V ta namen je treba montirati poseben ročaj.
- ⚠ Ta izdelek se sme uporabljati le z namenom umivanja, vzdrževanja higiene in telesne nege.
- ⚠ Velike razlike v tlaku med priključkom za mrzlo in priključkom za toplo vodo je potrebno izravnati.

Navodila za montažo

- Pred montažo je treba izdelek preveriti glede morebitnih transportnih poškodb. Po vgradnji transportne ali površinske poškodbe ne bodo več priznane.
- Cevi in armaturo je treba montirati, izprati in preveriti po veljavnih standardih.
- Upoštevat je treba pravilnike o inštalacijah, ki veljajo v posamezni državi.

Opis simbola

Ne smete uporabiti silikona, ki vsebuje očetno kislino!



Mere (glejte stran 19)



Diagram pretoka
(glejte stran 19)



Rezervni deli (glejte stran 20)



Poseben pribor (Ni vključeno)

Podaljšek 100 mm #97686000



Čiščenje

glejte priloženi brošuri

Συναρμολόγηση
βλ. Σελίδα 17



Montaža
glejte stran 17



⚠ Ohutusjuhised

- ⚠ Kandke paigaldamisel muljumis- ja löikevigastuste vältimiseks kindaid.
- ⚠ Toodet ei tohi kasutada käepidemena. Paigaldage eraldi käepide.
- ⚠ Toodet tohib kasutada ainult pesemis-, hügieeni- ja kehahastamisesmärkidel.
- ⚠ Kui külma ja kuuma vee ühenduste surve on väga erinev, tuleb need tasakaalustada.

Paigaldamisjuhised

- Enne paigaldamist tuleb toodet kontrollida transportdihajustuste osas Pärast paigaldamist ei tunnustata enam transporti- või pinnakahjustuste kaebuseid.
- Voolikute ja segisti paigaldamisel, loputamisel ja kontrollimisel tuleb lähtuda kehtivatest normatiividest
- Vastavas riigis kehtivaid paigalduseeskirju tuleb järgida.

Sümbolite kirjeldus



Ärge kasutage äädikhapet sisaldavat silikooni!



Mõõtude (vt lk 19)



Läbivooludiagramm

(vt lk 19)



Varuosad (vt lk 20)



Spetsiaalne lisavarustus (ei sisaldu komplektis)

Pikendus 100 mm #97686000



Puhastamine

vt kaasasolevast brošüürist

⚠ Drošības norādes

- ⚠ Montāžas laikā, lai izvairītos no saspiedumiem un iegriezumiem, nepieciešams nēsāt cimdus.
- ⚠ Šo produktu nedrīkst izmantot kā roku balstu. Nepieciešams uzmontēt atsevišķu roku balstu.
- ⚠ Šo produktu drīkst izmantot tikai, lai mazgātos, higiēnai un ķermeņa tīrīšanai.
- ⚠ Jāizlīdzina spiediena atšķirības starp aukstā un karstā ūdens pievadiem.

Norādījumi montāžai

- Pirms montāžas nepieciešams pārbaudīt, vai produktam transportēšanas laikā nav radušies bojājumi. Pēc iebūvēšanas bojājumi, kas radušies transportēšanas laikā, vai virsmas bojājumi netiek atzīti.
- Caurļvadi un armatūra ir jāuzstāda, jāizskalo un jāpārbauda saskaņā ar spēkā esošajiem standartiem.
- Jāievēro attiecīgās valsts spēkā esošās montāžas prasības.

Simbolu nozīme



Neizmantojot silikonu, kas satur etiķskābi!



Izmērus (skat. lpp. 19)



Caurplūdes diagramma

(skat. lpp. 19)



Rezerves daļas (skat. lpp. 20)



Speciāli aksesuāri (komplektā netiek piegādāti)

Pagarinājums 100 mm #97686000



Tīrīšana

skatiet pievienotajā brošūrā

Paigaldamine
vt lk 17



Montāža
skat. lpp. 17



! Sigurnosne napomene

- △ Prilikom montaže se radi sprečavanja prignječenja i posekotina moraju nositi rukavice.
- △ Proizvod se ne sme koristiti za kao ručka za pridržavanje. U tu svrhu se mora postaviti zaseban rukohvat.
- △ Proizvod sme da se koristi samo za kupanje, tuširanje i ličnu higijenu.
- △ Velika razlika u pritisku između vruće i hladne vode mora biti izbalansirana.

Instrukcije za montažu

- Pre montaže se mora proveriti da li je proizvod oštećen pri transportu. Nakon ugradnje se ne priznaju nikakve reklamacije koje se odnose na površinska i transportna oštećenja.
- Vodovi i armatura moraju biti postavljeni, isprani i testirani prema važećim normama.
- Treba se pridržavati propisa koji u određenim zemljama važe za instalacije.

Opis simbola



Nemojte koristiti silikon koji sadrži sirćetnu kiselinu!



Mere (vidi stranu 19)



Dijagram protoka
(vidi stranu 19)



Rezervni delovi (vidi stranu 20)



Poseban pribor (Nije sadržano u isporuci)

Produžetak 100 mm #97686000



Čišćenje
vidi priloženoj brošuri

! Sikkerheshenvisninger

- △ Bruk hanser under montasjen for å unngå klem- og kuttskader.
- △ Produktet skal ikke brukes som holdegrep. Det skal monteres en separat holdegrep.
- △ Produktet skal kun brukes for bade-, hygiene- og kroppshygiene.
- △ Store trykkdifferanser mellom kaldt- og varmtvannstilkoblinger skal utlignes.

Montagehenvisninger

- Før montasjen skal produktet sjekkes for transportskader. Etter monteringen aksepteres ikke noen transport- eller overflateskader.
- Ledningene og armaturen skal monteres, spyles og sjekkes iht. de gyldige normer.
- Gjeldende retningslinjer for rørleggerarbeid i de enkelte land skal følges.

Symbolbeskrivelse



Ikke bruk silikon som inneholder eddiksyre!



Mål (se side 19)



Gjennomstrømningsdiagram
(se side 19)



Servicelever (se side 20)



Ekstratilbehør (ikke med i leveransen)

Forlengelse 100 mm #97686000







Rengjøring
se vedlagt brosjyre





Указания за безопасност

-  При монтажа трябва да се носят ръкавици, за да се избегнат наранявания поради притискане или порязване.
-  Продуктът не бива да се използва като дръжка. Трябва да се монтира отделна дръжка.
-  Позволено е използването на продукта само за къпане, хигиена и цели на почистване на тялото.
-  Големите разлики в налягането между изводите за студената и топлата вода трябва да се изравняват.

Указания за монтаж

- Преди монтажа продуктът трябва да се провери за транспортни щети. След монтажа не се признават транспортни или повърхностни щети.
- Тръбопроводите и арматурата трябва да се монтират, промият и проверят в съответствие с валидните норми.
- Трябва да бъдат спазвани валидните в съответните страни предписания за инсталиране.

Описание на символите

 Не използвайте силикон, съдържащ оцетна киселина!

 **Размери** (вижте стр. 19)

 **Диаграма на потока**
(вижте стр. 19)





 **Сервизни части** (вижте стр. 20)

 **Специални принадлежности**
(не се съдържа в обема на доставка)

Удължител 100 мм #97686000

 **Почистване**
от приложената брошура

Udhëzime sigurie

-  Për të evituar lëndimet e pickimeve ose të prerjeve gjatë procesit të montimit duhet që të vishni doreza.
-  Produkti nuk duhet të përdoret si dorëze mbajtëse. Duhet të montohet një dorëzë mbajtëse e veçantë.
-  Produkti duhet të përdoret vetëm qëllimet e banjave, të higjienës dhe të larjes së trupit.
-  Ndryshimet e mëdha të presionit mes lidhjeve të ujit të ftohtë dhe atij të ngrohtë duhen ekuilibruar.

Udhëzime për montimin

- Përpara montimit duhet që produkti të kontrollohet për dëmtime nga transporti. Pas instalimit nuk do të njihet asnjë dëmtim nga transporti ose dëmtim i sipërfaqes.
- Tubacionet dhe rubinetet duhet që të montohen, të shpëlahen dhe të kontrollohen sipas standardeve në fuqi.
- Duhet të respektohen linjat udhëzuese të instalimit, të vlefshme për vendet respektive.

Përshkrimi i simbolit

 Mos përdorni silikon që në përbërje ka acid acetik.

 **Përmasat** (shih faqen 19)

 **Diagrami i qarkullimit**
(shih faqen 19)

 **Pjesët e servisit** (shih faqen 20)

 **Pajisje të posaçme** (nuk përfshihet në vëllimin e furnizimit)

Zgjatësi 100 mm #97686000

 **Pastrimi**
shikoni broshurën bashkëngjitur

Монтаж
вижте стр. 17



Montimi
shih faqen 17



⚠ تنبيهات الأمان

- ⚠ يجب إرتداء قفازات لليد أثناء التركيب لتجنب حدوث أخطار الإنحشار أو الجروح.
- ⚠ ممنوع إستخدام المنتج كمقبض. يجب تركيب مقبض منفصل.
- ⚠ لا يجب استخدام المنتج إلا في أغراض الاستحمام والأغراض الصحية وأغراض تنظيف الجسم.
- ⚠ يجب أن يكون تيار الماء الساخن والماء البارد متعادلين في الضغط.

تعليمات التركيب

- قبل القيام بعملية التركيب، يجب فحص المنتج للتأكد من خلوه من أية تلفيات ناتجة عن النقل. بعد القيام بعملية التركيب، لن يتم الاعتراف بوجود أية تلفيات سطحية أو تلفيات ناتجة عن عملية النقل.
- يجب تركيب وغسيل واختبار التوصيلات وخلطات المياه طبقاً للمعايير السارية.
- يجب مراعاة القواعد الخاصة بالتركيب وأعمال السباكة وفقاً للوائح الخاصة بكل بلد.

وصف الرمز

- هام! لا تستخدم السليكون الذي يحتوي على أحماض! 
- أبعاد (راجع صفحة 19) 
- رسم للصرف (راجع صفحة 19) 
- قطع الغيار (راجع صفحة 20) 
- ملحقات خاصة (غير مدرج مع المحتويات المسلمة) 
- وصلة إطالة 100 مم #97686000
- التنظيف 
- راجع والكتيب المرفق

التركيب

راجع صفحة 17



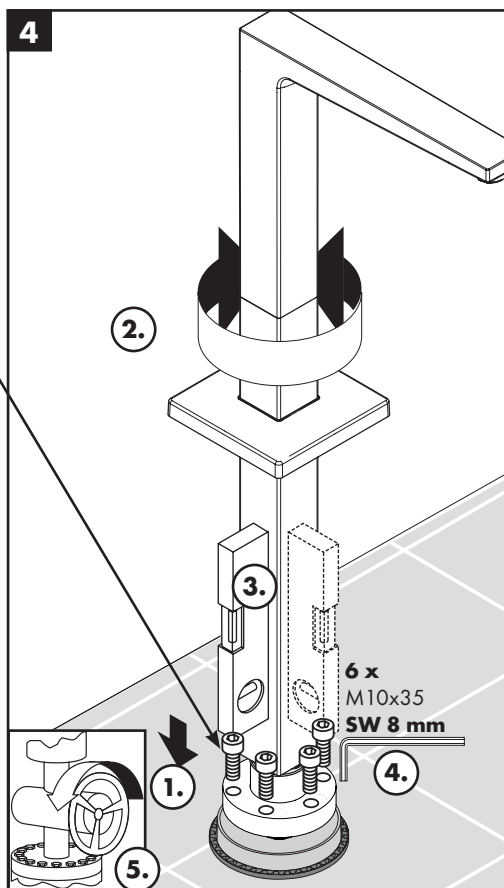
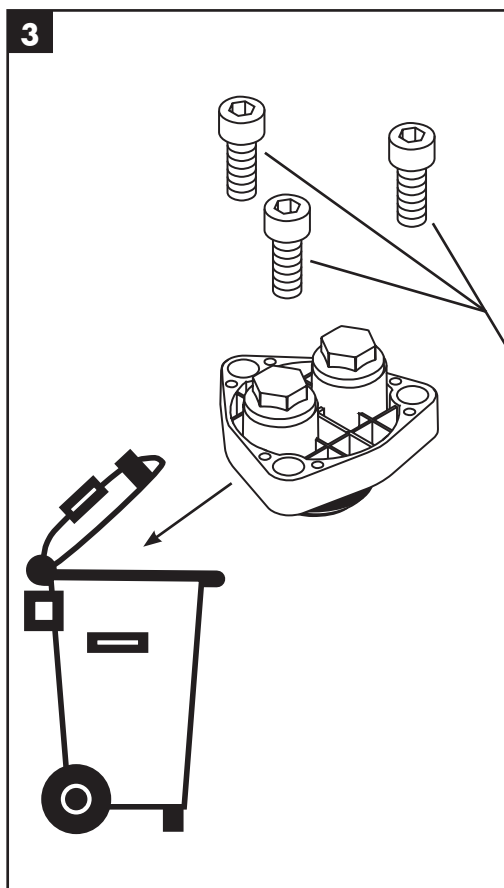
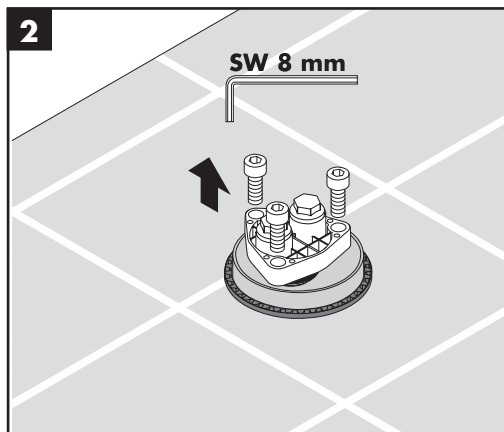
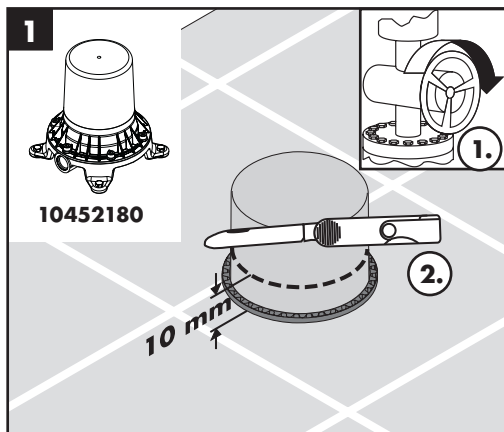

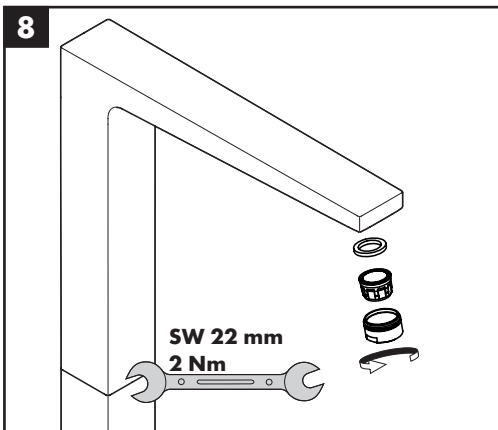
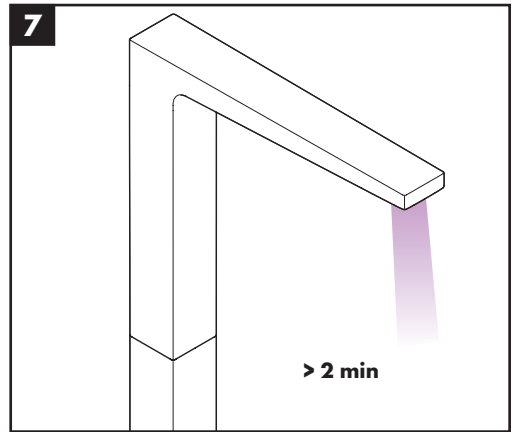
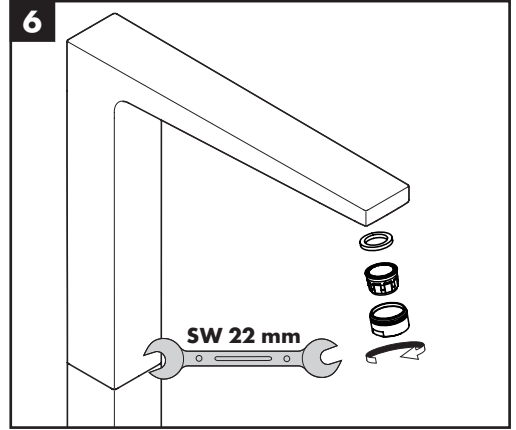
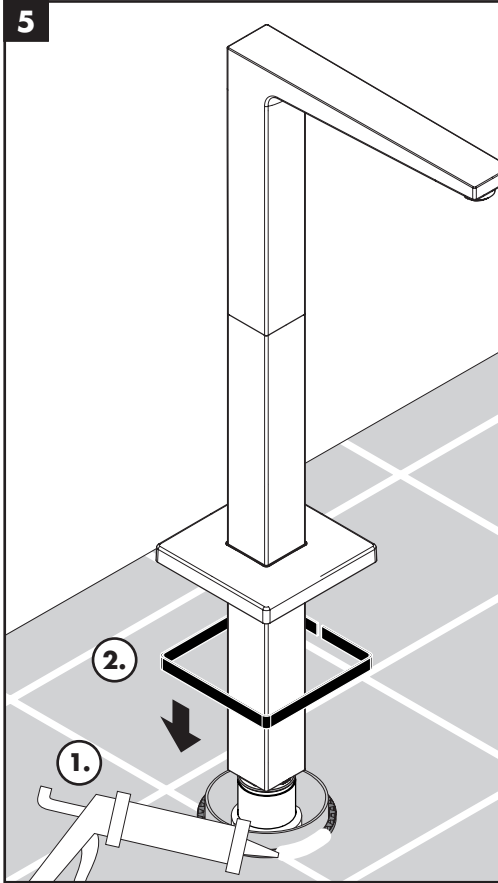

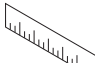

Metropol
32531000

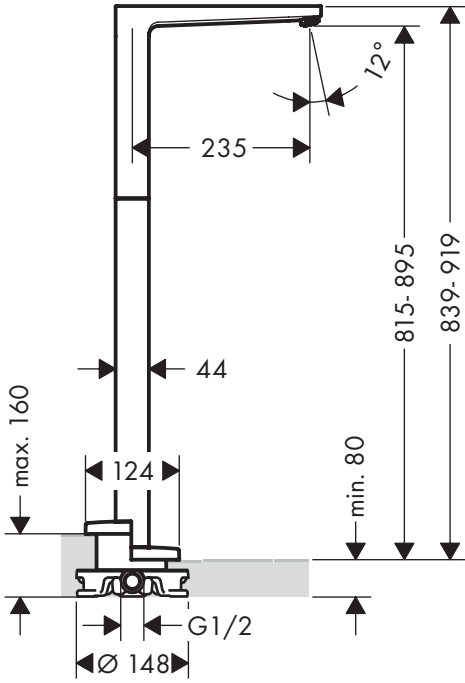

Metropol
32531000

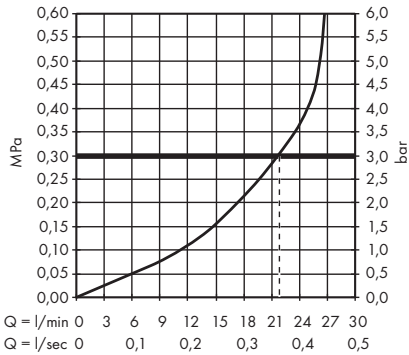



Metropol
32531000

