

DE Montageanleitung

EN Mounting instruction

ES Instrucciones de instalación

FR Instructions d'installation

IT Istruzioni per l'installazione

NL Montagehandleiding

CS Návod k instalaci

PL Instrukcja montażu

RU Инструкция по монтажу

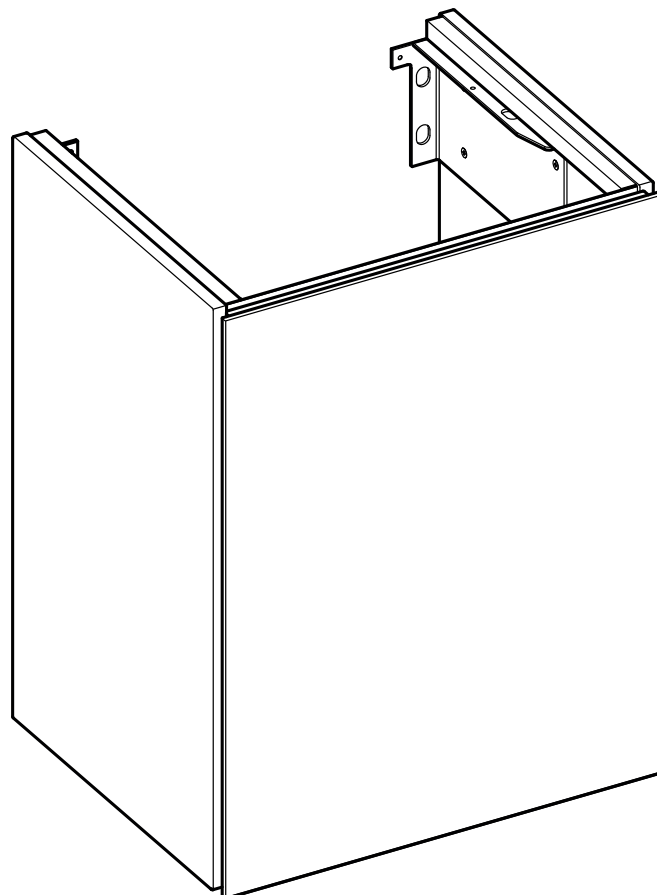

33122 110001	33122 110002
33122 140001	33122 140002
33122 180001	33122 180002
33122 290001	33122 290002
33122 300001	33122 300002

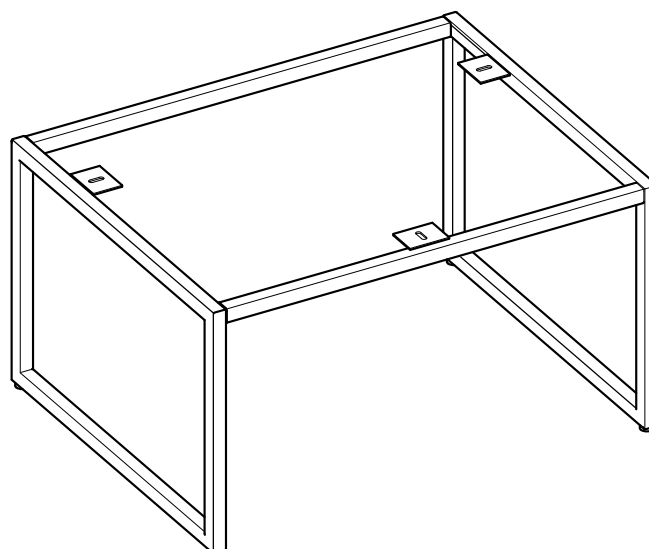

33198 110007
33198 140007
33198 180007
33198 290007
33198 300007

DE Einbaumaße

FR Dimensions de montage

CS Montážní rozměry

EN Mounting dimensions

IT Dimensioni di montaggio

PL Wymiary montażowe

ES Dimensiones de montaje

NL Montageafmetingen

RU Установочные размеры

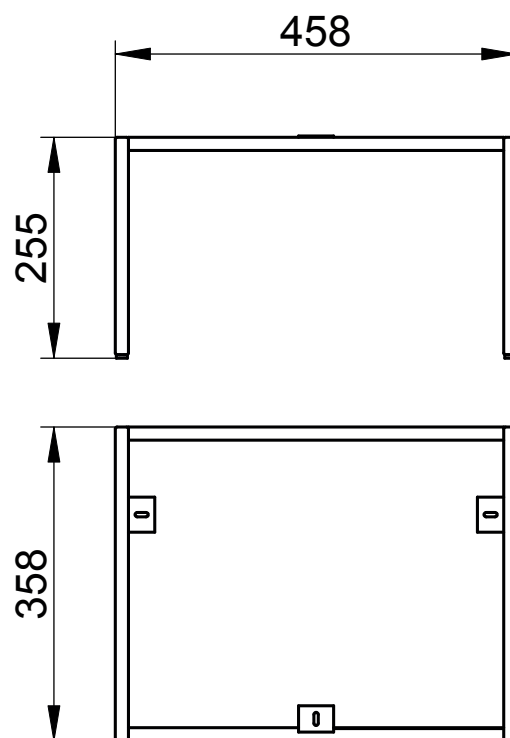
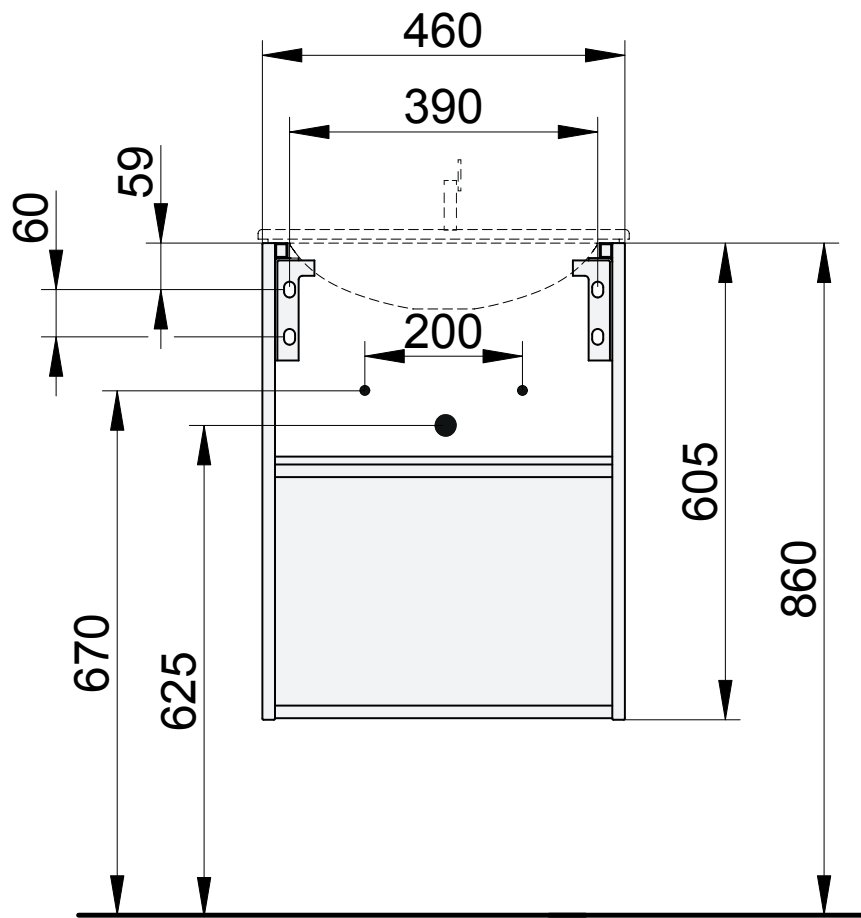

DE Wichtige Informationen, bitte unbedingt lesen!

 Diese Anleitung ist für den Installateur zur Montage sowie für den Nutzer zur Bedienung und Wartung des Produktes. Bitte nach der Installation an den Nutzer zur Verwahrung weitergeben.

Symbole und Bedeutung

 **Achtung!** Warnung vor Personen- oder Sachschaden.

 **Achtung!** Warnung vor Stromschlag.

 **Achtung!** Warnung vor Wasserschaden.

 Hinweis, Tipp oder Verweis

 Korrekte Montage/Funktionsprüfung

 Falsche Montage

 Montagedetail beachten

 Optional/Zubehör

 Bestätigungston/Klickgeräusch

 Beiliegende Dokumentation beachten!

Sicherheitsinformationen

 – Vor der Montage muss sichergestellt werden, dass die Wand das Gewicht tragen kann.
– Zur Vermeidung von Personen- und Sachschäden muss die Montage von zwei Personen durchgeführt werden.

 Produkt ausschließlich zur Montage in Innenräumen geeignet!

 **Achtung!** Installation nur in frostfreien Räumen.

Einbaumaße, siehe Seite 2.

Installation, siehe ab Bild 1 auf Seite 8.

 Hinweise zur Gewährleistung und Pflege sind dem beiliegendem **Pflege- und Garantiepäss** zu entnehmen.

EN Important information, please make sure to read!

 These instructions are designed for the installation engineer to assemble the product and for the user to operate and maintain it. After installation, please pass them on to the user for safekeeping.

Symbols and their meaning

 **Caution!** Warning of personal injury or material damage

 **Caution!** Warning of electric shock.

 **Caution!** Warning of water damage.

 Note, tip or reference

 Correct assembly/functional test

 Incorrect assembly

 Observe assembly details

 Optional/accessories

 Confirmation tone/click sound

 Observe enclosed documentation!

Safety Information

 – Prior to installation it must be ensured that the wall can support the weight of the mirror.
– To prevent personal injury or material damage the assembly must be carried out by two persons.

 The product is suitable only for mounting indoors!

 **Caution!** Only install in frost-free rooms.

Mounting dimensions, see page 2.

Installation, see figure 1 onwards on page 8.

 For information about warranty and maintenance, see the enclosed **Maintenance and Warranty Passport**.



Este manual está destinado al instalador para el montaje, así al usuario para el manejo y mantenimiento del producto. Por favor, después de la instalación este manual se debe entregar al usuario para que lo conserve.

Símbolos y significado

¡Atención! Advertencia de daños personales o materiales.



¡Atención! Advertencia de descarga eléctrica.



¡Atención! Advertencia de daños a causa del agua.



Indicación, consejo o referencia



Montaje correcto/Comprobación de funcionamiento



Montaje erróneo



Observar el detalle de montaje



Opcional/Acesorios



Tono de confirmación/Ruido de clic



¡Observe la documentación adjunta!

Informaciones de seguridad

- Antes del montaje se debe asegurar, que la pared puede soportar el peso.
- Para evitar daños personales y materiales el montaje tiene que ser llevado a cabo con dos personas.



¡Producto exclusivamente para el montaje en interiores!



¡Atención! Instalación exclusivamente en espacios sin hielo.

Medidas de montaje, véase página 2.

Instalación, véase imagen 1 en la página 8.



En el **pasaporte de cuidado y garantía** adjunto encontrará indicaciones sobre la garantía y el cuidado.



Ces instructions sont destinées à l'installateur, pour effectuer le montage, et à l'utilisateur, pour utiliser le produit et procéder à sa maintenance. Après l'installation, veuillez remettre ces instructions à l'utilisateur pour qu'il les conserve.

Symboles et leur signification

Attention ! Mise en garde contre les dégâts de personnes et les dégâts matériels.



Attention ! Mise en garde contre les chocs électriques.



Attention ! Mise en garde contre les endommagements par l'eau.



Remarque, conseil ou renvoi



Montage correct/contrôle fonctionnel



Montage incorrect



Respecter le détail de montage



Option/accessoires



Tonalité de confirmation/clic



Respecter la documentation jointe !

Informations en matière de sécurité

- Avant le montage, il convient de s'assurer que le mur peut supporter le poids.
- Pour éviter les les dégâts de personnes et les dégâts matériels, le montage doit être effectué par deux personnes.



Le produit ne convient que pour un montage à l'intérieur !



Attention ! Installation uniquement dans des pièces à l'abri du gel.

Côtes d'encombrement, voir page 2.

Installation, voir à partir de la figure 1, à la page 8.



Les consignes relatives à la garantie et à l'entretien figurent sur la **carte d'entretien et de garantie** jointe.



Il presente manuale è indirizzato agli installatori per il montaggio nonché agli utilizzatori per l'uso e la manutenzione del prodotto. Consegnarlo all'utilizzatore dopo l'installazione affinché lo custodisca.

Simboli e significato

Attenzione! Pericolo di lesioni o danni materiali.



Attenzione! Pericolo di folgorazione.



Attenzione! Pericolo di danni causati dall'acqua.



Avvertenza, consiglio o rimando



Montaggio corretto/verifica del funzionamento



Montaggio errato



Prestare attenzione al dettaglio di montaggio



Opzionale/accessorio



Tono di conferma/suono a clic



Osservare la documentazione allegata!

Informazioni di sicurezza

- Prima del montaggio occorre garantire che la parete possa sostenere il peso.
- Al fine di evitare lesioni e danni materiali il montaggio deve essere eseguito da due persone.



Prodotto adatto esclusivamente per il montaggio in ambienti interni!



Attenzione! Installazione solo in ambienti in assenza di gelo.

Dimensioni di montaggio, vedi pagina 2.

Installazione, vedi dalla figura 1 a pagina 8.



Indicazioni relative alla garanzia e al trattamento vanno desunte dalla **relativa scheda**.



Deze handleiding is zowel voor de installatiemonteur, als voor de gebruiker voor de bediening en het onderhoud van het product bedoeld. Geef de handleiding na de installatie aan de gebruiker om te bewaren.

Symbolen en betekenis

Opgepast! Waarschuwing voor lichamelijke en materiële schade.



Opgepast! Waarschuwing voor elektrische schokken.



Opgepast! Waarschuwing voor waterschade.



Aanwijzing, tip of verwijzing



Controle van correcte montage/werking



Verkeerde montage



Montagedetail respecteren



Optioneel/accessoire



Bevestigingston/klikgeluid



Meegeleverde documentatie respecteren!

Veiligheidsinformatie

- Voor de montage moet worden gecontroleerd of de wand het gewicht van de spiegel kan dragen.
- Om schade aan personen of zaken te vermijden moet de montage door twee personen worden uitgevoerd.



Het product is uitsluitend voor montage in binnenruimten geschikt!



Opgepast! Installatie alleen in vorstvrije ruimten.

Inbouwafmetingen, zie pagina 2.

Installatie, zie vanaf afbeelding 1 op pagina 8.













Aanwijzingen over de garantie en het onderhoud kunnen in het bijgevoegde **Onderhouds- en garantiëblad** worden bekeken.





CS Důležité informace, prosíme, bezpodmínečně si je přečtěte!

 Tento návod slouží instalatérům při montáži a uživatélům při obsluze a údržbě produktu. Po nainstalování ho předejte uživateli, aby si ho mohl uschovat.

Symbole a jejich význam

-  **Pozor!** Výstraha před zraněním a materiálními škodami.
-  **Pozor!** Výstraha před úrazem elektrickým proudem.
-  **Pozor!** Výstraha před poškozením vodou.
-  Upozornění, tip nebo odkaz
-  Správná montáž / kontrola funkčnosti
-  Nesprávná montáž
-  Při montáži dbejte na tento detail
-  Volitelná výbava / příslušenství
-  Potvrzovací tón / zvuk kliknutí
-  Respektujte přiloženou dokumentaci!

Informace o bezpečnosti

-  – Před montáží musí být zajištěno, že stěna unese dané zatížení.
-  – Aby se zabránilo zraněním a materiálním škodám, musí montáž provádět dvě osoby.
-  Výrobek je vhodný výhradně k montáži ve vnitřních prostorech!
-  **Pozor!** Instalace v prostorech, které nepromrzají.

Montážní rozměry viz strana 2.











Instalace vizobr. 1 na straně 8.

 Pokyny týkající se záruky a péče najdete v přiloženém **Návodu k údržbě a záručním listu**.





PL Ważne informacje. Proszę koniecznie przeczytać!

 Instrukcja przeznaczona jest dla instalatora, zapewniając pomoc w zakresie montażu oraz dla użytkownika, informując go o sposobie obsługi i konserwacji produktu. Po instalacji należy przekazać instrukcję użytkownikowi, aby ją u siebie przechowywał.

Symbole i znaczenie

-  **Uwaga!** Ostrzeżenie przed szkodami osobowymi i materialnymi.
-  **Uwaga!** Ostrzeżenie przed porażeniem prądem elektrycznym.
-  **Uwaga!** Ostrzeżenie przed szkodami, spowodowanymi przez wodę.
-  Informacja, dobra rada lub odsyłacz
-  Właściwy montaż / kontrola funkcjonowania
-  Niewłaściwy montaż
-  Należy stosować się do danych, dotyczących montażu
-  Opcje / Osprzęt
-  Dźwięk potwierdzający / dźwięk kliknięcia
-  Należy stosować się do załączonej dokumentacji!

Informacje dotyczące bezpieczeństwa

-  – Przed montażem należy upewnić się, że ściana jest w stanie unieść ciężar.
-  – W celu uniknięcia szkód osobowych i materialnych montaż powinny wykonywać dwie osoby.
-  Produkt przeznaczony jest wyłącznie do montażu wewnątrz budynków!
-  **Uwaga!** Instalacja wyłącznie w pomieszczeniach, w których temperatura nie spada poniżej zera.

Wymiary zabudowy, patrz strona 2.

Instalacja, patrz rys. 1 na stronie 8 i dalsze.

 Informacje dotyczące gwarancji dostępne są w dołączonej **karcie pielęgnacyjno-gwarancyjnej**.



Данная инструкция сборки установки составлена для пользователя для облегчения обслуживания и упрощения эксплуатации. Пожалуйста, после установки сохраните данную инструкцию.

Символы и их значение



Внимание! Опасность получения травм или повреждений.



Внимание! Опасность поражения электрическим током.



Внимание! Опасность получения повреждений от воды.



Совет, подсказка или ссылка



Правильная сборка/функционирование



Неправильна сборка



Используйте монтажные детали



Дополнительные комплектующие



Звук / щелчок при нажатии



См. сопроводительную документацию.

Информация по технике безопасности



- Перед монтажом следует убедиться, что стена сможет выдержать вес зеркала.
- Во избежание получения травм или повреждений установка продукта должна осуществляться двумя специалистами.



Продукт подходит только для установки внутри помещений!



Внимание! Установка продукта возможна только в теплых помещениях.

Габариты установки, см. на странице 2.

Установка, см. на рисунке 1 на странице 8.



Указания по гарантийному и техническому обслуживанию содержатся в **талоне сервисного и гарантийного обслуживания**.

