

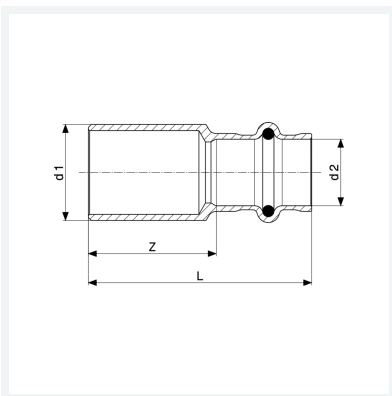

**Sanpress-Muffe
mit SC-Contur**
- Pressanschlüsse
Ausstattung
Dichtelemente EPDM
Modell 2215

Artikel 282 660



Eigenschaften

Rohraußendurchmesser	d	18
Z-Maß	Z	8 mm
Länge	L	52 mm
Gewicht	46,2 g	
Volumen	82,88 cm ³	
Werkstoff	Rotguss oder Siliziumbronze	