

Montageanleitung

nextVIT Schnellverbinder

Installation instructions

nextVIT quick connectors

Weitere Informationen zu
unseren Produkten finden Sie
auch unter www.mepa.de



For more information on
our products, please visit
www.mepa.de

Sämtliche Bild-, Produkt-, Maß- und Ausführungsangaben der vorliegenden Information entsprechen dem Tag der Drucklegung.
Modelländerungen, die dem technischen Fortschritt bzw. der Weiterentwicklung dienen, sind vorbehalten.
Alle genannten Produkt- und Firmenbezeichnungen sowie Marken sind Eigentum ihrer jeweiligen Inhaber.

All above images and information regarding products, measurements and models were correct when the publication went to press.
We reserve the right to make changes to models as a result of technical progress or further development.
All product and company names as well as trademarks mentioned are the property of their respective owners.

	Seite / Page
1 Wichtige Hinweise / Important information	04
2 Lieferumfang / Scope of delivery	05
3 Montage / Installation	07

(DE) Angaben zur Montageanleitung
Zielgruppe dieser Montageanleitung**(DE)****(EN) Details about the installation instructions**
Target group for these installation instructions**(EN)**

Die gezeigten Produkte sind nur durch zugelassene Fachhandwerksbetriebe unter Beachtung dieser Montageanleitung sowie der maßgebenden Normen, Richtlinien, Bestimmungen und Vorschriften zu installieren, einzustellen und in Betrieb zu nehmen. Daher richtet sich diese Montageanleitung an qualifizierte Sanitär-Installateure.

The products are intended to be installed only by licensed sanitary fitters, under the acknowledgement of these installation instructions as well as the given norms, rules, and regulations. Due to the strict guidelines and the precision work that is required when installing the products, these instructions are intended for licensed sanitary fitters.

Pflichten im Umgang mit dieser Montageanleitung

Jede Person, die Arbeiten an dem beiliegenden Produkt vornimmt, es insbesondere montiert, reinigt oder entsorgt, muss den vollständigen Inhalt dieser Montageanleitung zur Kenntnis genommen und verstanden haben.

Obligations related to these installation instructions

Anyone who installs, cleans, or disposes of the accompanying products, must have acknowledged and understood the complete installation instructions.

Bestimmungsgemäßer Gebrauch





Zum bestimmungsgemäßen Gebrauch gehört die Beachtung aller maßgebenden Normen, Richtlinien, Bestimmungen und Vorschriften sowie der Informationen in dieser Montageanleitung, insbesondere die Beachtung der Sicherheitshinweise. Jede andere Verwendung gilt als nicht bestimmungsgemäß und kann zu Sachschäden oder sogar zu Personenschäden führen. Der Hersteller schließt die Haftung für Schäden, die durch nicht bestimmungsgemäßen Gebrauch entstehen, aus.

Proper use

Proper use includes heeding all of the norms, rules, and regulations, as well as other information included in these installation instructions, particularly the safety instructions. Any other use is regarded as improper and can result in property damage or even personal injuries. The manufacturer will not accept liability for any damage caused by improper use.

Status 04.2024

Stand 04.2024

				
(DE) Gefahr	Achtung	Hinweis	Auf Dichtheit prüfen/achten	Warnung vor elektrischer Spannung
(EN) Danger	Caution	Note	Check/look for leaks	Warning of electrical voltage

Diese Informationen finden Sie in weiteren Sprachen unter:

You can find this information in other languages at:

www.mepa.de/hinweise



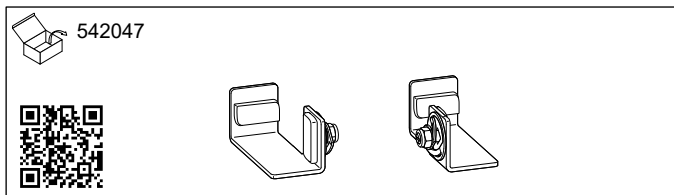
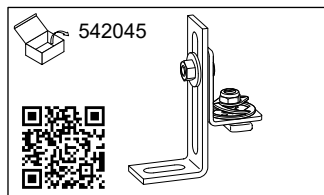
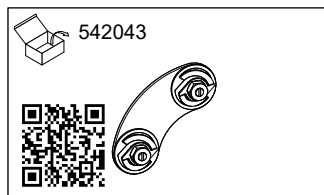
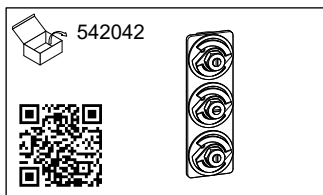
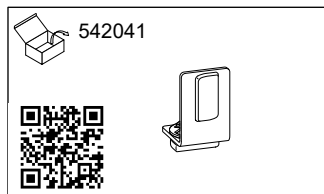
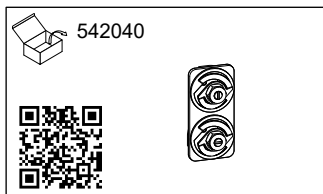

542040

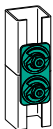
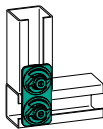
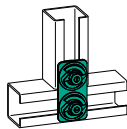
**A1****A2****A3**

542041

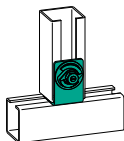
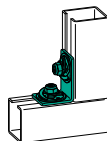
**B1.1 - B1.4****B2**

542042

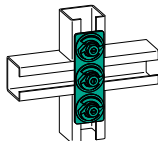
**C1**

542043

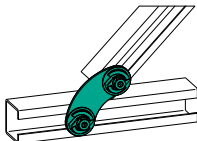
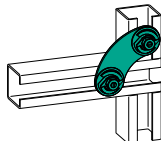
**D1****D2**

542044

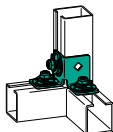
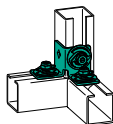
**E1 + E2.1****E1 + E2.2**

542047

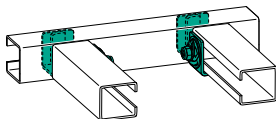
**F1 - F3**

542045

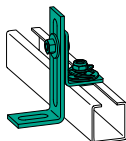
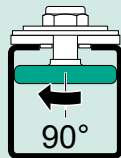
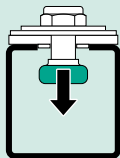
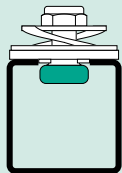
**G1****Info**

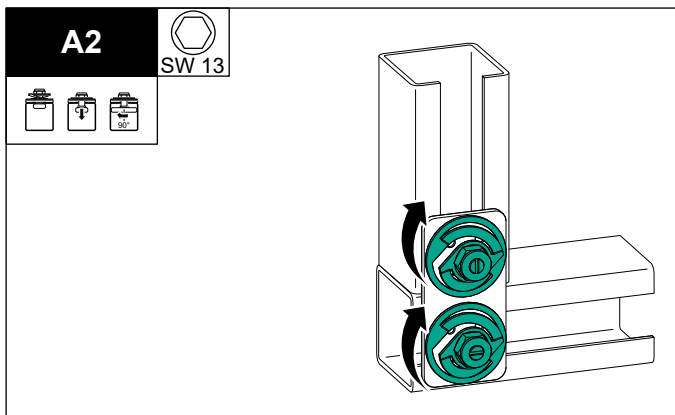
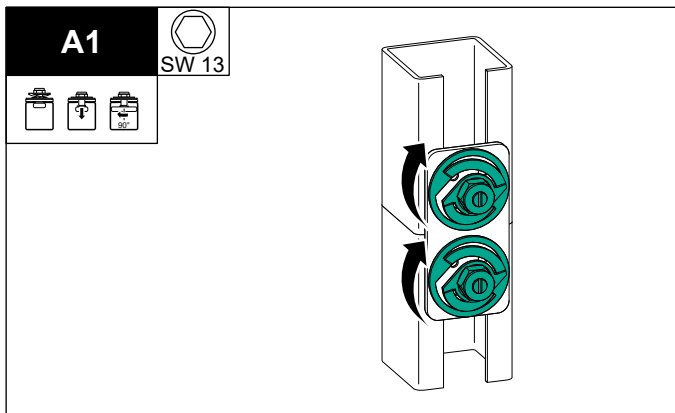

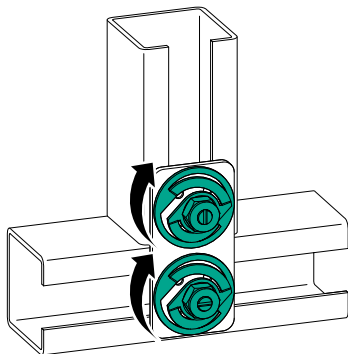
A3

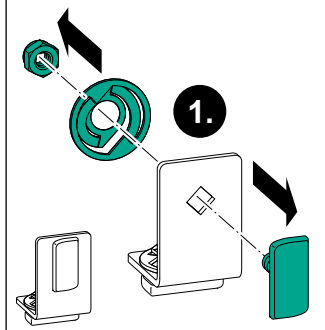
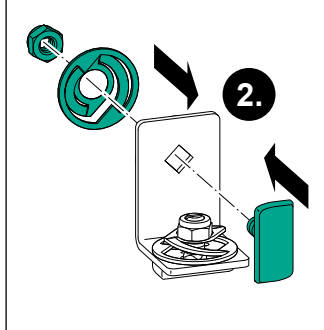
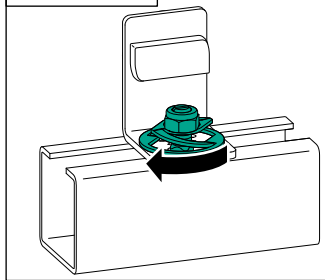
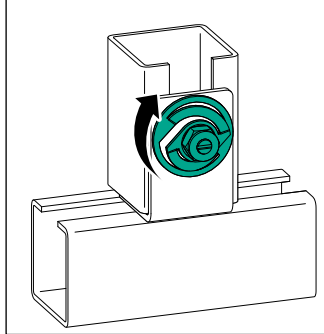
B1.1**B1.2****B1.3****B1.4**

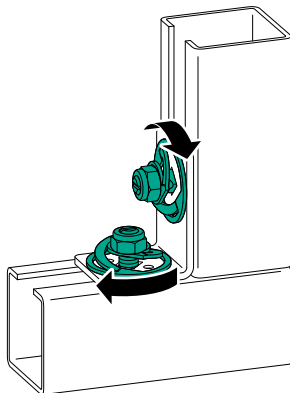
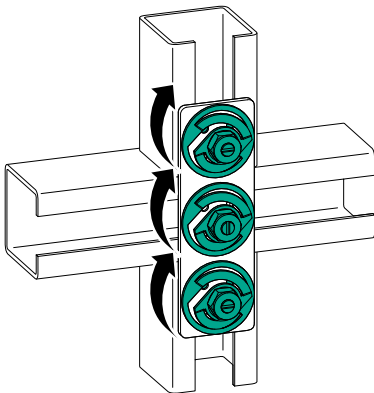
B2**C1**

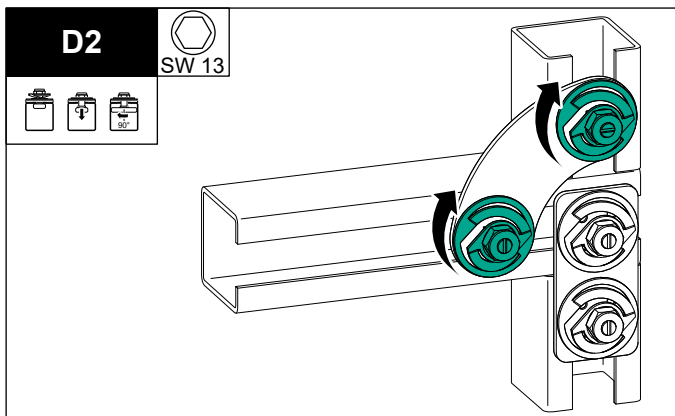
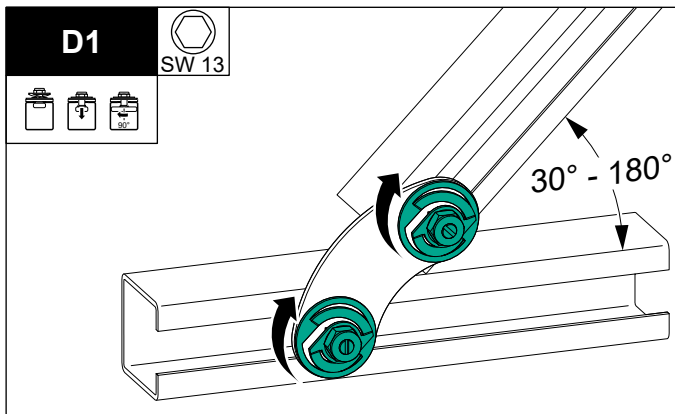

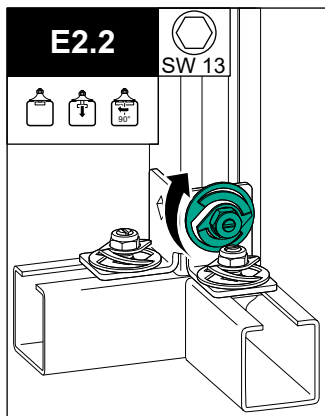
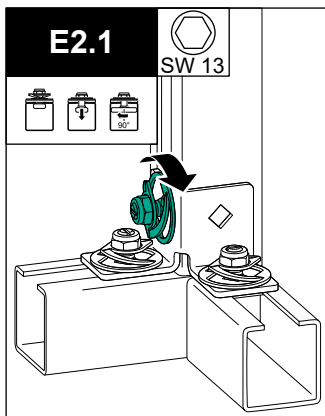
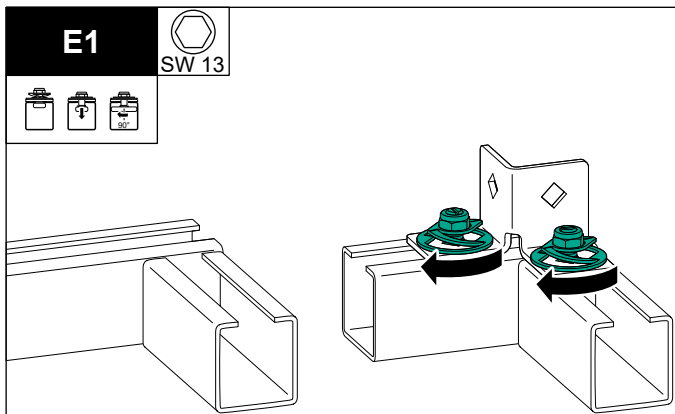

F1



SW 13

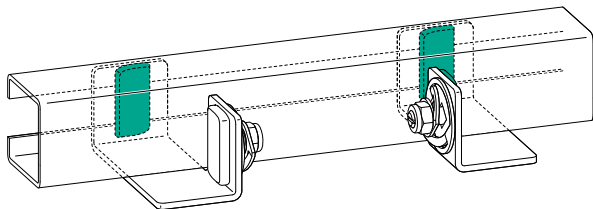

F2



SW 13

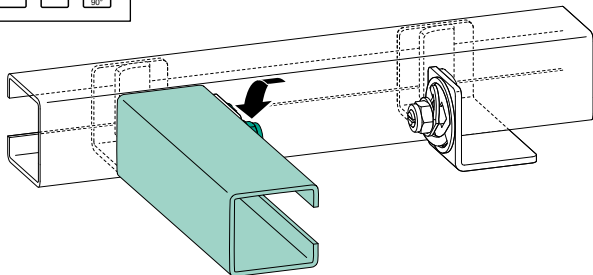

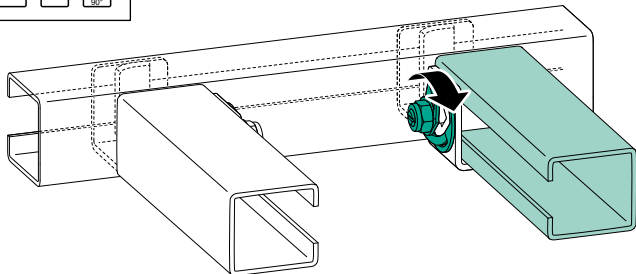
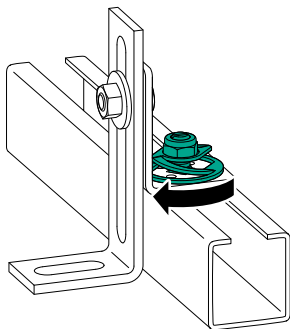
F3**G1**



MEPA – Pauli und Menden GmbH

Hauptwerk und Vertrieb

Rolandsecker Weg 37 | D-53619 Rheinbreitbach

Tel. +49 (0) 22 24 / 929 - 0 | Fax +49 (0) 22 24 / 929 - 149

www.mepa.de | info@mepa.de



Schreiben Sie uns

www.mepa.de/whatsapp



powered by

REHAU