

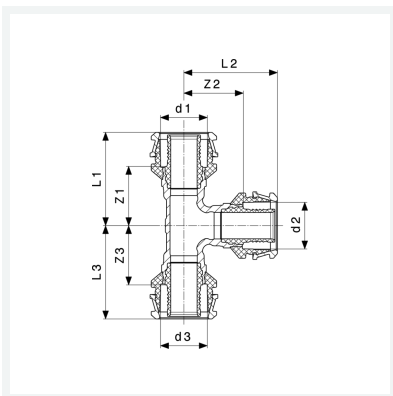

**Raxofix-T-Stück
mit SC-Contur**
- Pressanschlüsse
Modell 5318

Artikel 647 278



Eigenschaften

Rohraußendurchmesser 1	d1	16
Rohraußendurchmesser 2	d2	16
Rohraußendurchmesser 3	d3	16
Z-Maß 1	Z1	23 mm
Z-Maß 2	Z2	23 mm
Z-Maß 3	Z3	23 mm
Länge 1	L1	38 mm
Länge 2	L2	38 mm
Länge 3	L3	38 mm
Gewicht	76 g	



**Raxofix-T-Stück
mit SC-Contur
Modell 5318
Artikel 647 278**

Eigenschaften

Volumen	124,32 cm ³
Werkstoff	Siliziumbronze