



**Sanpress-Bogen 45°
mit SC-Contur**

- Pressanschlüsse

Ausstattung

Dichtelemente EPDM

Modell 2226

Artikel 116 156

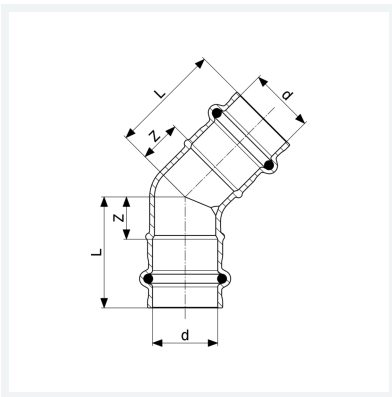

Eigenschaften

Rohraußendurchmesser	d	35
Z-Maß	Z	24 mm
Länge	L	49 mm
Gewicht	217,9 g	
Volumen	355,2 cm ³	
Werkstoff	Rotguss oder Siliziumbronze	