



Reduzierstück
- R-Gewinde, Rp-Gewinde

Ausstattung

Mehrkant

Modell 3241

Artikel 281 823

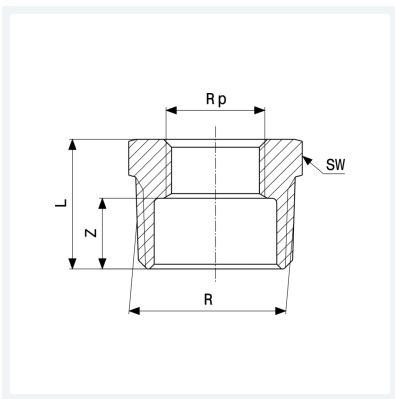

Eigenschaften

Außengewinde kegelig	R	$\frac{3}{8}$
Innengewinde zylindrisch	Rp	$\frac{1}{4}$
Z-Maß	Z	6 mm
Länge	L	17 mm
Schlüsselweite	SW	18 mm
Gewicht	14,61 g	
Volumen	15,54 cm ³	
Werkstoff	Rotguss oder Siliziumbronze	