

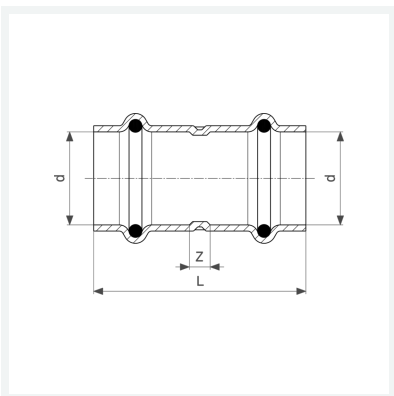

**Prestabo-Muffe  
mit SC-Contur**  
- Pressanschlüsse  
**Ausstattung**  
Dichtelemente EPDM  
**Modell 1115**  
  
**Artikel 558 024**



## Eigenschaften

VdS-Zulassung	VdS	✓
Rohraußendurchmesser	d	35
Z-Maß	Z	12 mm
Länge	L	64 mm
Gewicht	98,5 g	
Volumen	248,64 cm <sup>3</sup>	
Werkstoff	Stahl unlegiert, verzinkt	