

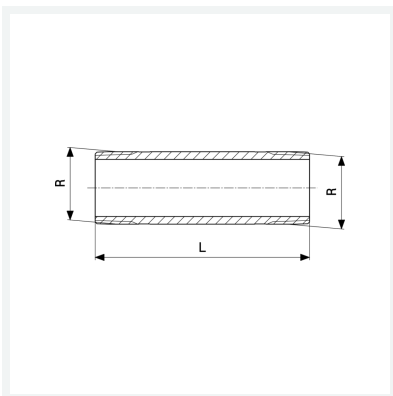

**Langnippel**  
- R-Gewinde  
**Modell 3530**

**Artikel 267 407**



## Eigenschaften

Länge	L	80
Außengewinde kegelig	R	¾
Länge	L	80 mm
Gewicht	166,7 g	
Volumen	165,76 cm <sup>3</sup>	
Werkstoff	Rotguss oder Siliziumbronze	