

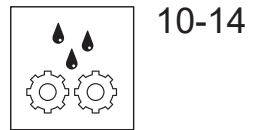

HANSA

Installation and maintenance guide

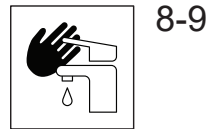

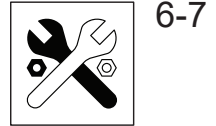

5815 0071

EN 1111
100 - 1000 kPa
0.19 l/s (Eco)
0.32 l/s (300 kPa)

max. +80°C

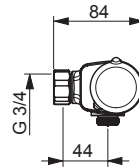
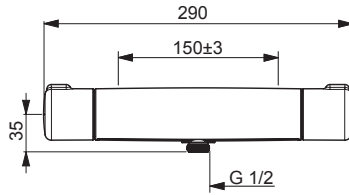

mpi.hansa.com/58150071

5815 0171 , 5815 0171 33, 5815 0171 0006, 5815 0171 0007, 5815 0171 0009

EN 1111
100 - 1000 kPa
0.19 l/s (Eco)
0.083 l/s (Eco)(0006)
0.116 l/s (Eco)(0007)
0.141 l/s (Eco)(0009)
0.32 l/s (300 kPa)
0.1 l/s (300 kPa w/Controller)(0006)
0.125 l/s (300 kPa w/Controller)(0007)
0.15 l/s (300 kPa w/Controller)(0009)

max. +80°C

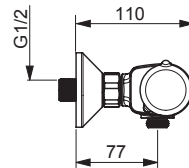
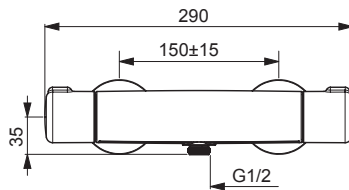

mpi.hansa.com/58150171

5815 2171

EN 1111
100 - 1000 kPa
0.19 l/s (Eco)
0.32 l/s (300 kPa)

max. +80°C

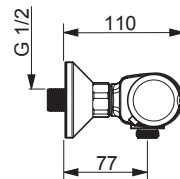
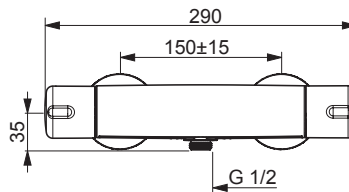

mpi.hansa.com/58152171



5816 2171 , 5816 2171 33

EN 1111
 100 - 1000 kPa
 0.34 / 0.32 l/s (300 kPa)
 max. +80°C

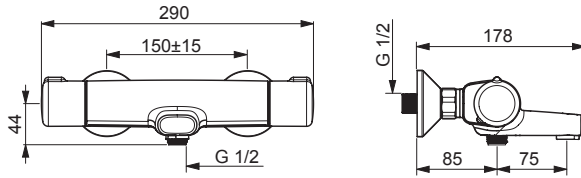

mpi.hansa.com/58162171

4815 0171 (5815 0171 + 4467 0133)

EN 1111
 100 - 1000 kPa
 0.20 l/s (300 kPa)
 max. +80°C

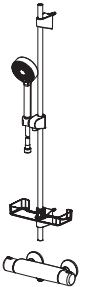
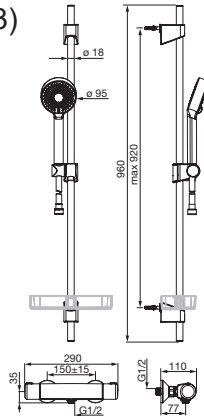

mpi.hansa.com/48150171

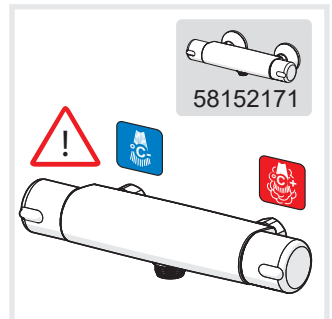
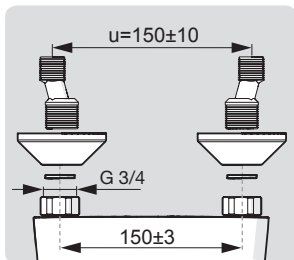
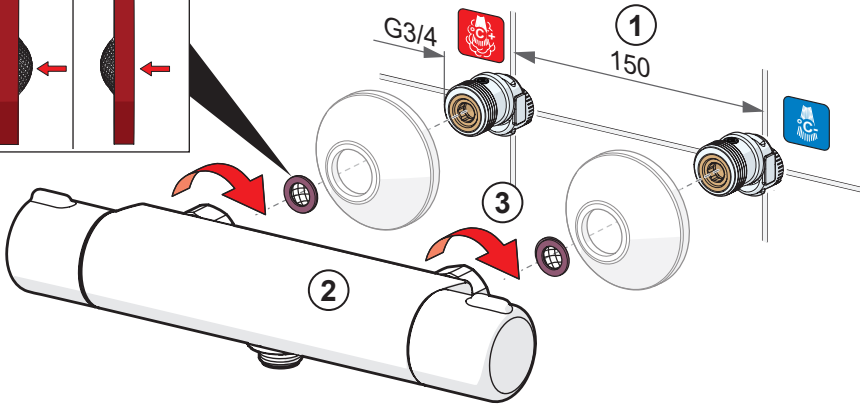
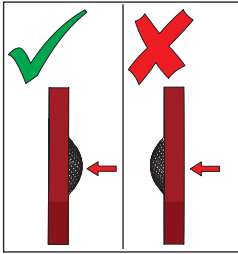
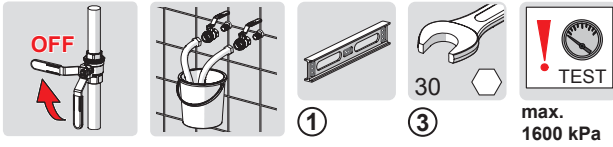

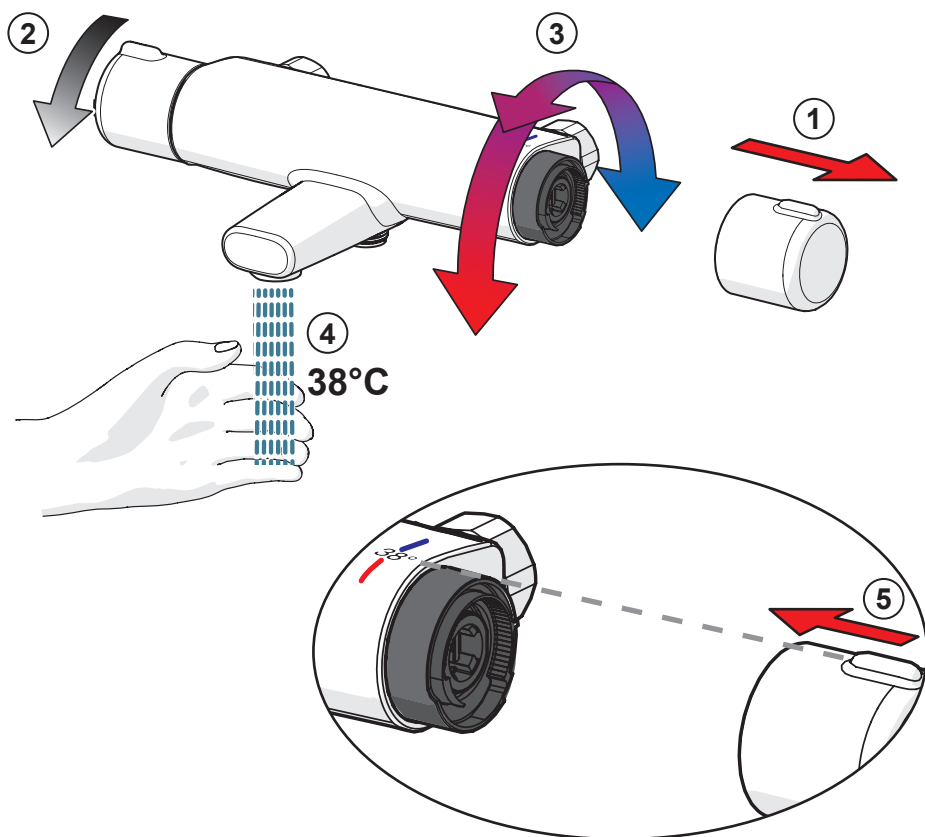

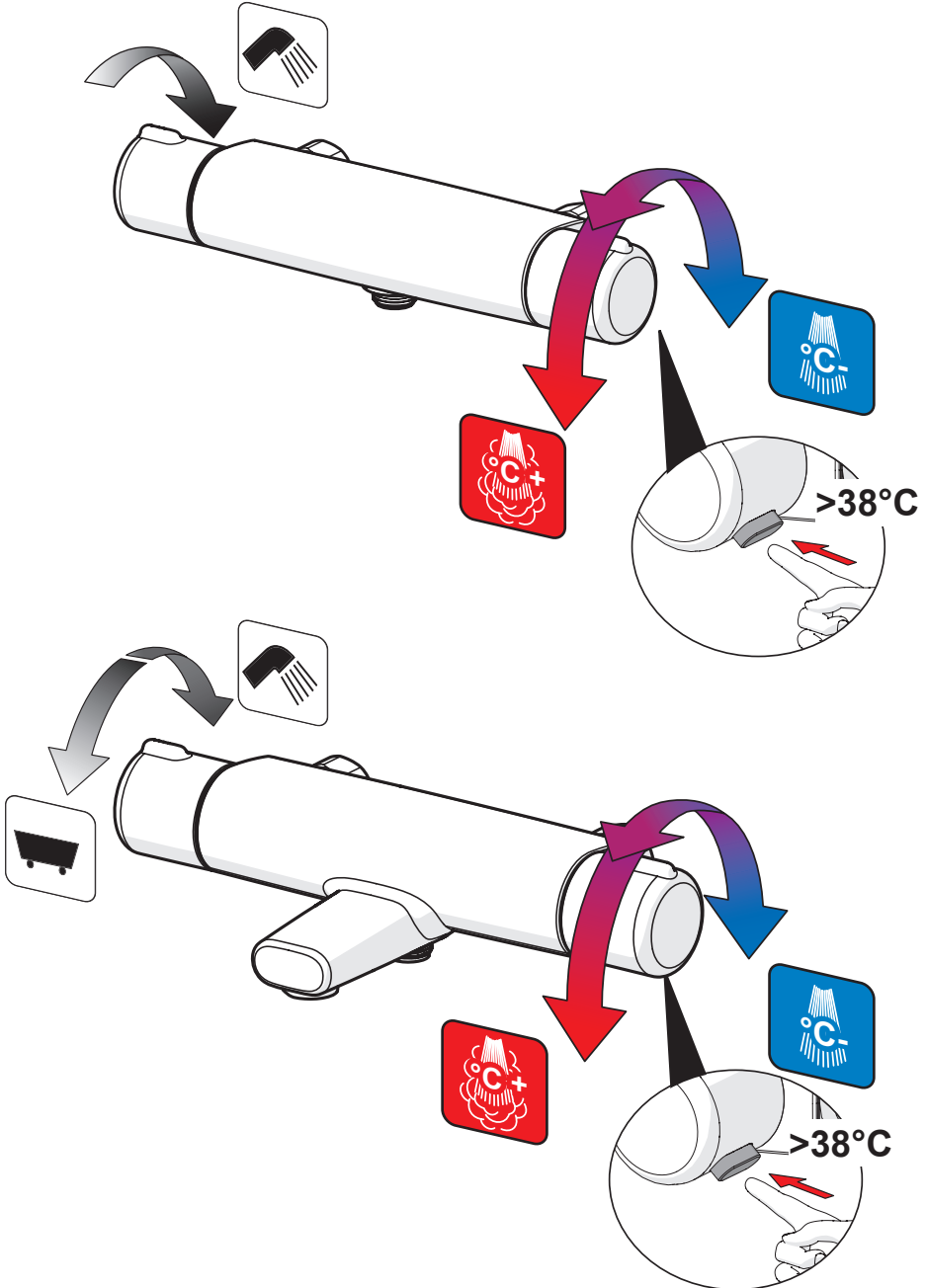

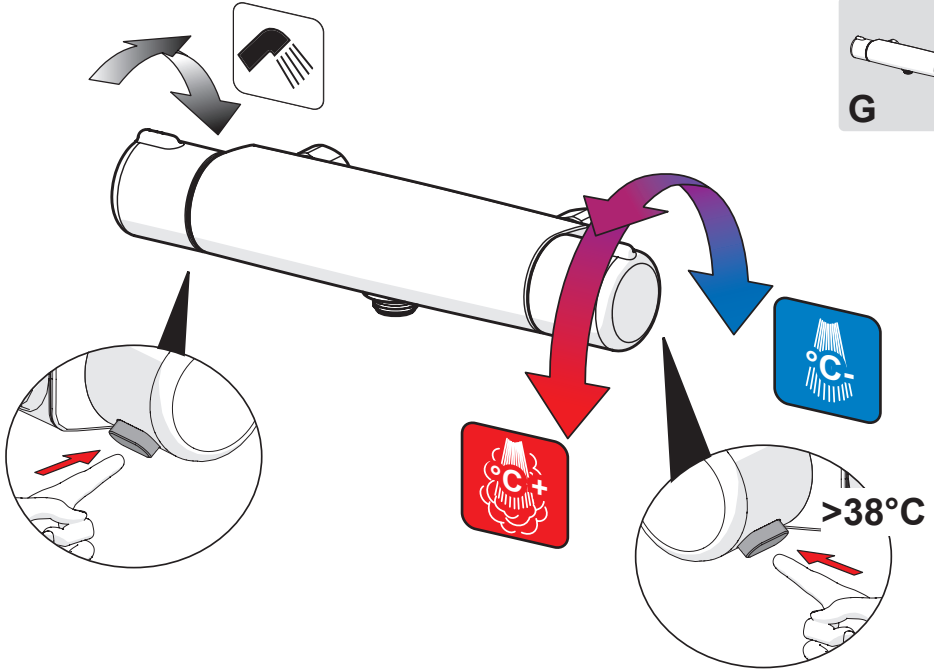

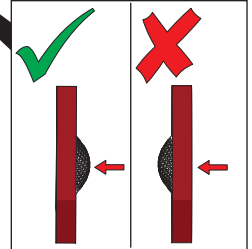
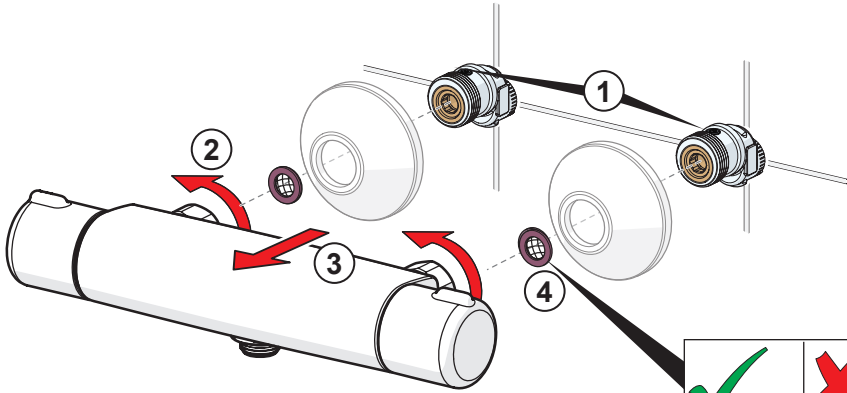
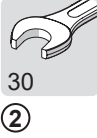
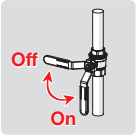
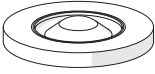

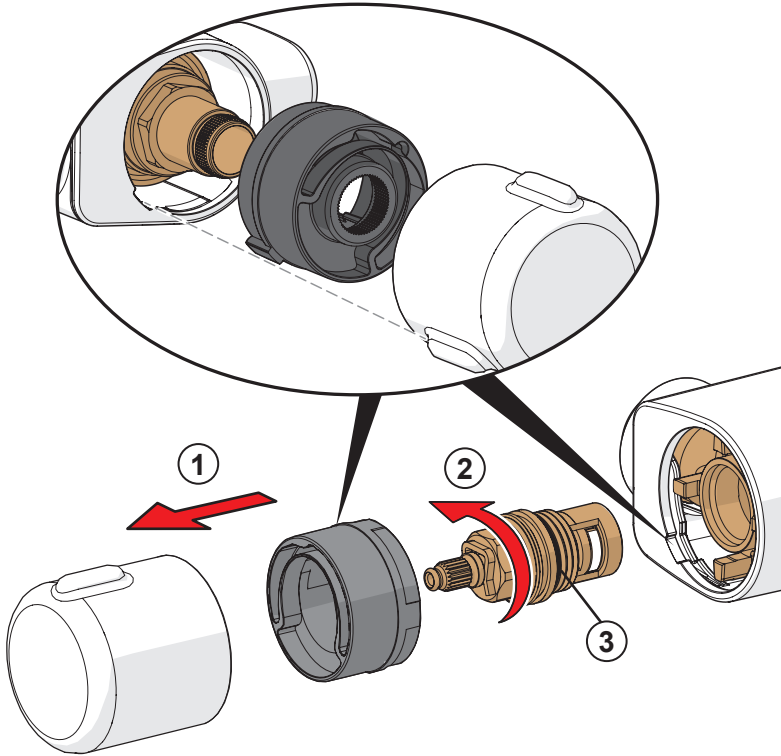
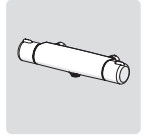
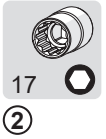
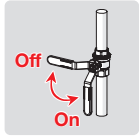

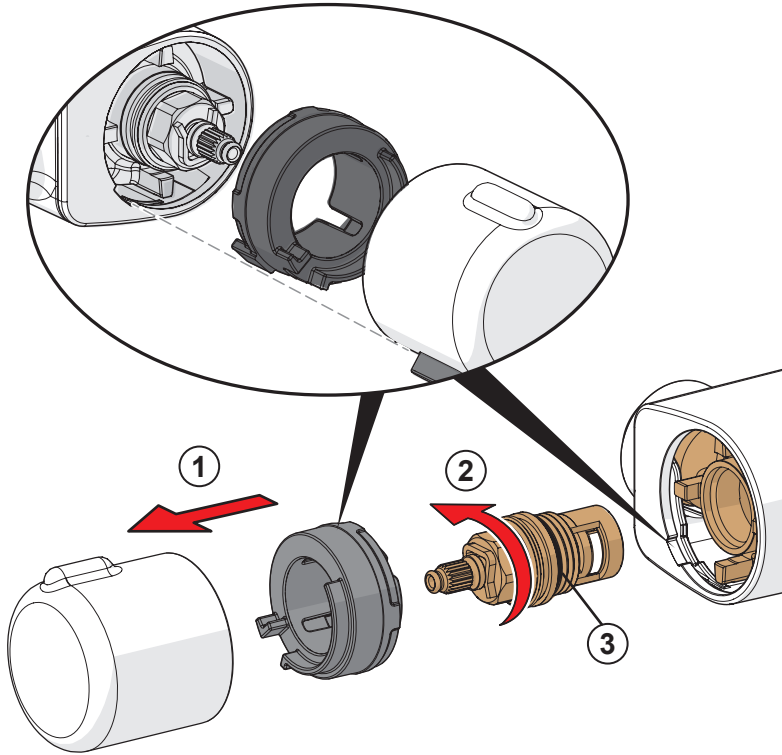
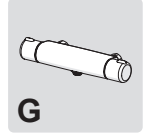
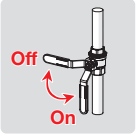

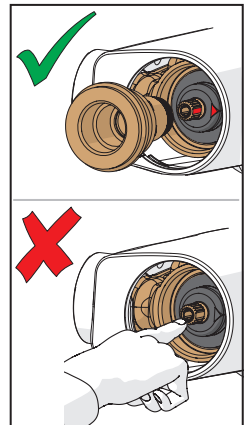
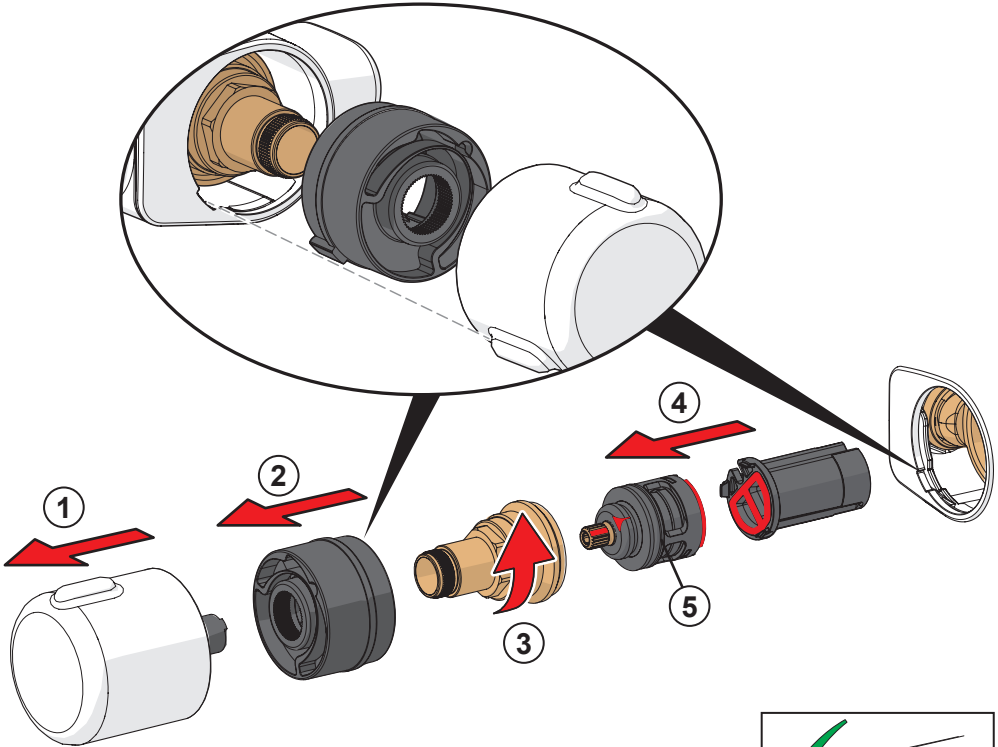
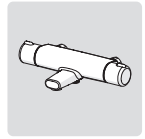
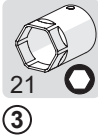
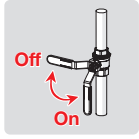
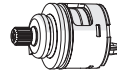

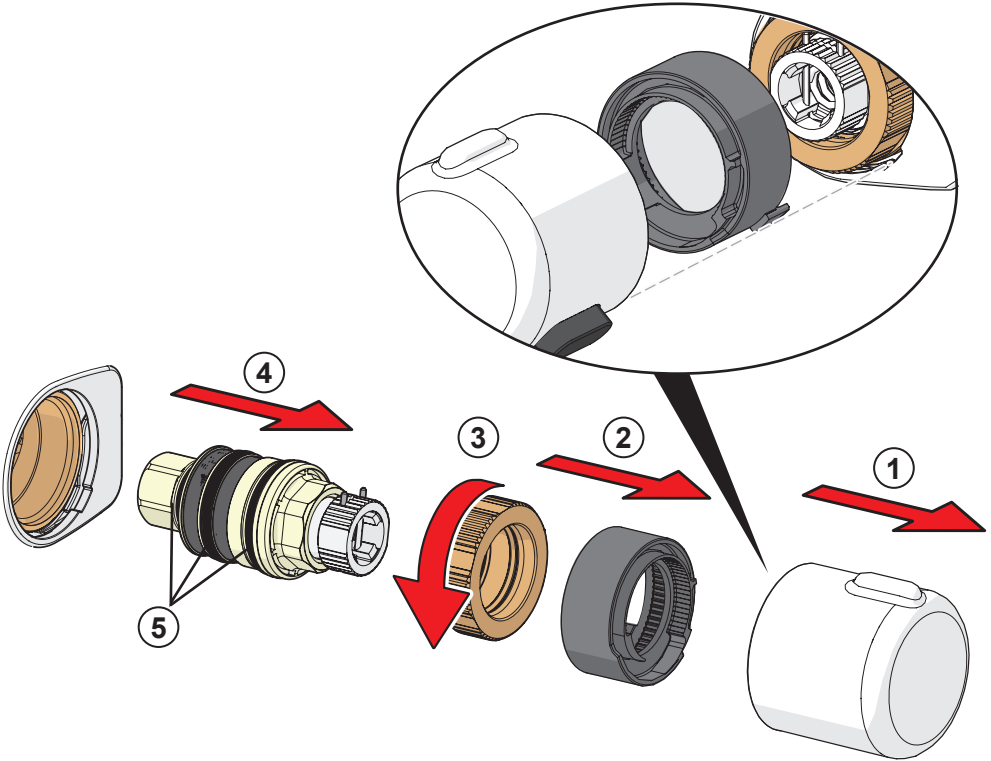
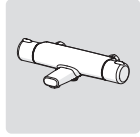
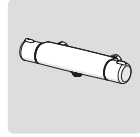
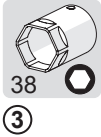

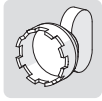

①



②

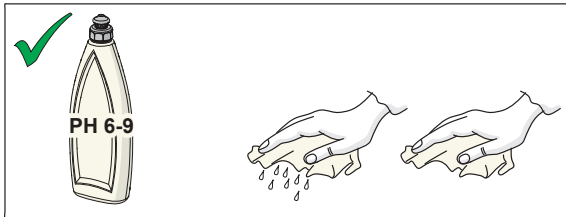
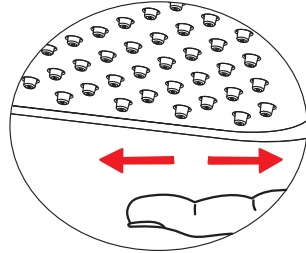
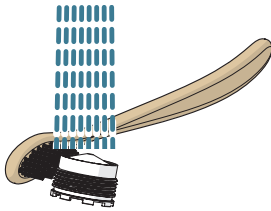

cleaning.hansa.com

About Oras Group

Oras Group is a significant European provider of sanitary fittings: the market leader in the Nordics and a leading company in Continental Europe.

The company's mission is to create the smartest water experiences for everyone and its vision is to become the Perfect Flow Company.

The Group has two strong brands, Oras and Hansa. Oras Group is owned by Oras Invest, a family company, and an industrial owner.

The domicile of Oras Ltd, the parent company of the Group, is located in Rauma, Finland, and the Group has three manufacturing sites: Kralovice (Czech Republic), Olesno (Poland) and Rauma (Finland).

The Group operates with its own staff in 17 markets. Oras Group's net sales were 233.5 million euros in 2021 and at the end of the period the company employed 1255 people.

HANSA Armaturen GmbH
P. O. BOX 81 02 40
D-70519 Stuttgart
Sigmaringer Strasse 107
D-70567 Stuttgart
Tel.: +49 711 16 14 0
Fax: +49 711 16 14 368
info@hansa.de
www.hansa.com

