

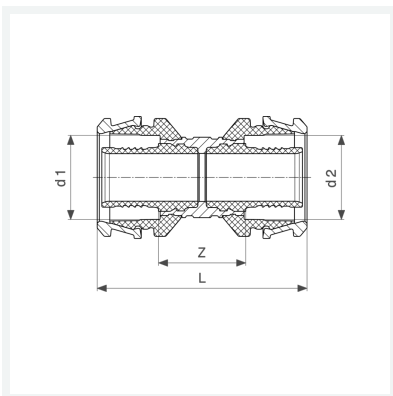

**Raxofix-Kupplung  
mit SC-Contur**  
- Pressanschluss  
**Modell 5315**

**Artikel 646 882**



## Eigenschaften

Rohraußendurchmesser 1	d1	32
Rohraußendurchmesser 2	d2	25
Z-Maß	Z	28 mm
Länge	L	67 mm
Gewicht	150 g	
Volumen	207,2 cm <sup>3</sup>	
Werkstoff	Siliziumbronze	