







28 450 410



- Brauseabgang 1/2"
- Rosette Ø 55 mm
- Anschluss 1/2"

Eigensicher gegen Rückfließen.

Passt zu MADISON

	Platin	28 450 410-08
	Chrom	28 450 410-00
	Platin gebürstet	28 450 410-06
	Messing (23kt Gold)	28 450 410-09
	Messing gebürstet (23kt Gold)	28 450 410-28
	Dark Platinum gebürstet	28 450 410-99

Empfohlenes Zubehör



UP-Wandwinkel -

- Max. Einbautiefe 163 mm
- Min. Einbautiefe 90 mm

35 085 970 90

28 450 410

mm [inches]

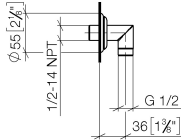

Durchflussdiagramm



Codes & Standards

EN 1717

Scottish Water
Byelaws

UK Water Supply
Regulations



MADISON Wandanschlussbogen - Platin

MADISON

28 450 410

Zertifikate

WRAS_1809

Belgaqua_21-381-2

28 450 410

Produktversion bis 7/6/2018

Produktversion ab 7/6/2018

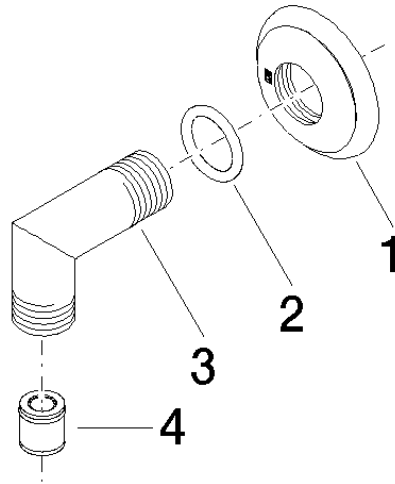



28 450 410

Ersatzteilstückliste

Produktversion bis 7/6/2018

Produktversion ab 7/6/2018

Nr.	Artikelnummer	Benennung	Verbaumenge	Lieferzeit
	09 27 35 003-08	Rosette Ø 55 x Ø 27 x 10 mm - Platin	4	40