













20 713 892



- Ausladung 165 mm
- Ablaufgarnitur 1 1/4"
- schwenkbarer Auslauf 360°
- runder luftangereicherter Strahl
- Armaturenhöhe 285 mm
- Höhe bis Luftsprudler 163 mm
- Bohrungsdurchmesser Seitenventil 32 mm
- Bohrungsdurchmesser Auslauf 35 mm
- Rosette Ø 55 mm
- 2x Druckschlauch M 10 x 1 eingeschraubt, dichtheitsgeprüft
- Durchfluss max. 7 l/min
- bleifrei
- Dieses Produkt leistet einen Beitrag zur Erfüllung der Vorgaben von nachhaltigen Gebäudezertifizierungen, z.B. LEED®, BREEAM®, DGNB

Nur für Becken mit Überlauf geeignet.

	Chrom	20 713 892-00
	Platin gebürstet	20 713 892-06
	Platin	20 713 892-08
	Dark Chrome	20 713 892-19
	Light Gold gebürstet	20 713 892-27
	Messing gebürstet (23kt Gold)	20 713 892-28
	Schwarz matt	20 713 892-33
	Bronze gebürstet	20 713 892-42
	Champagne gebürstet (22kt Gold)	20 713 892-46
	Champagne (22kt Gold)	20 713 892-47
	Chrom gebürstet	20 713 892-93
	Dark Platinum gebürstet	20 713 892-99

Empfohlenes Zubehör



Druckschläuche - 12 506 970 90
 • 2x Druckschlauch 3/8" x 1/2" x 500 mm

20 713 892

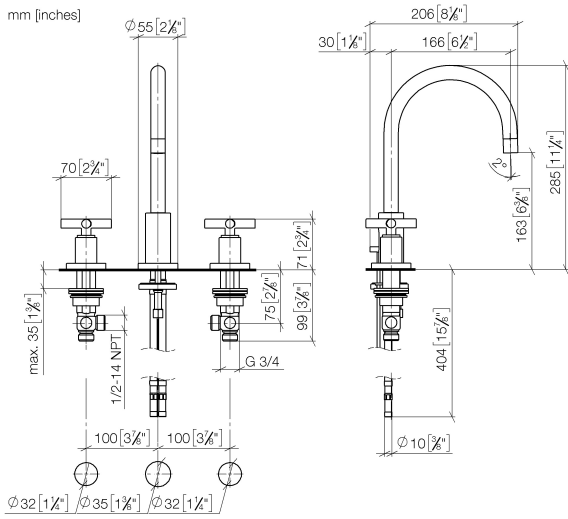

Durchflussdiagramm



Codes & Standards

DIN 4109	EN 200	Executive Order no. 1007	ISO 3822
Scottish Water Byelaws	UK Water Supply Regulations	Ü-Zeichen	VA-Zeichen
XP P 41-280			



TARA Waschtisch-Dreilochbatterie mit Ablaufgarnitur - Chrom

TARA

20 713 892

Zertifikate

LGA_18

GDV_0400

ACS_20 ACC LY

ETA_18

WRAS_2212

20 713 892

Produktversion bis 6/30/2009

Produktversion ab 6/30/2009

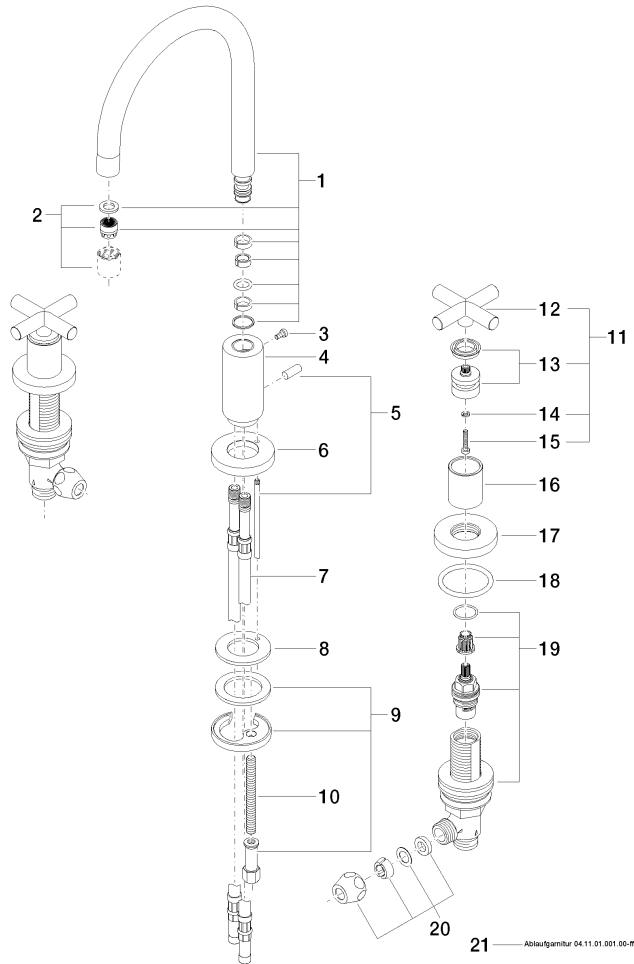



TARA Waschtisch-Dreilochbatterie mit Ablaufgarnitur - Chrom

TARA

20 713 892

Ersatzteilstückliste

Produktversion bis 6/30/2009

Produktversion ab 6/30/2009

Nr.	Artikelnummer	Benennung	Verbaumenge	Lieferzeit
	90 28 22 213 01-00	Auslauf 165 mm, 7 l/min. - Chrom	34	10