



## Temponox-Schiebemuffe mit SC-Contur

- Pressanschlüsse

### Ausstattung

Dichtelemente EPDM

**Modell 1715.5**

**Artikel 809 232**

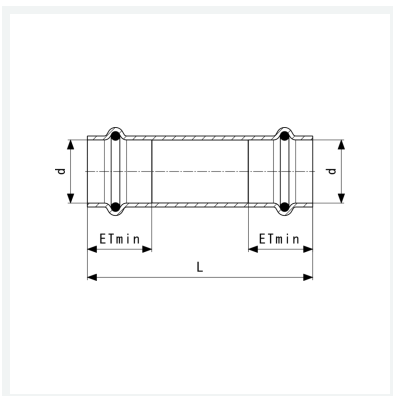

## Eigenschaften

Rohraußendurchmesser	d	28
Einstecktiefe minimal	ETmin	24 mm
Länge	L	96 mm
Gewicht	110 g	
Volumen	248,64 cm <sup>3</sup>	
Werkstoff	Stahl nichtrostend	