

**Haken - Schwarz matt**

MEM















83 251 220

- Ausladung 55 mm

Passt zu ELIO, ENO, MEM, META SQUARE, SYNC und TARA ULTRA



Passt zu: MEM, ELIO, ENO, TARA ULTRA, SYNC, META SQUARE

	Schwarz matt	83 251 220-33
	Chrom	83 251 220-00
	Platin gebürstet	83 251 220-06
	Platin	83 251 220-08
	Messing (23kt Gold)	83 251 220-09
	Dark Chrome	83 251 220-19
	Light Gold	83 251 220-26
	Light Gold gebürstet	83 251 220-27
	Messing gebürstet (23kt Gold)	83 251 220-28
	Bronze gebürstet	83 251 220-42
	Champagne gebürstet (22kt Gold)	83 251 220-46
	Champagne (22kt Gold)	83 251 220-47
	Chrom gebürstet	83 251 220-93
	Dark Platinum gebürstet	83 251 220-99

# Haken - Schwarz matt

MEM

83 251 220

mm [inches]

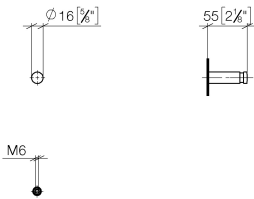

83 251 220

**Produktversion ab 10/1/2023**

Ersatzteile für die  
anderen  
Oberflächenvarianten  
finden Sie hier:  
Chrom

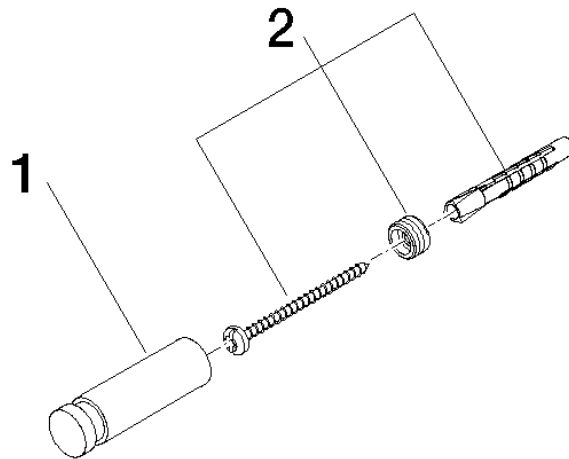



## Haken - Schwarz matt

MEM

83 251 220

### Ersatzteilstückliste

#### Produktversion ab 10/1/2023

Nr.	Artikelnummer	Benennung	Verbaumenge	Lieferzeit
	08 18 60 505-33	Haken 16 x 16 x 55 mm - Schwarz matt	2	-

Ersatzteil nicht mehr bestellbar, bitte bestellen Sie den Nachfolgeartikel