

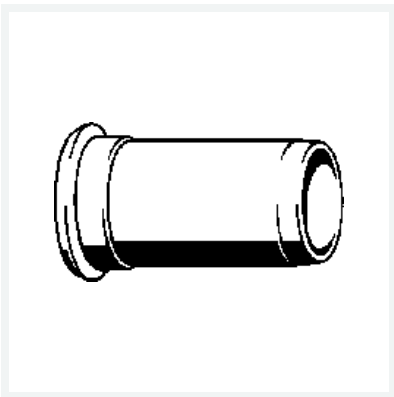

Maxiplex-Stützhülse
- für Maxiplex-Klemmverbinder, Wasseranwendung
Modell 9005

Artikel 275 525



Eigenschaften

Für Rohraußendurchmesser	für d	40
Gewicht	15,5 g	
Volumen	155,4 cm ³	
Werkstoff	PE	