

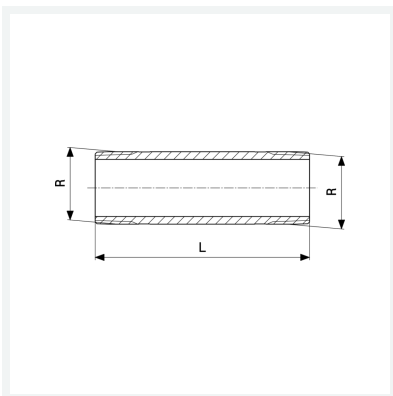

Langnippel
- R-Gewinde
Modell 3530

Artikel 318 512



Eigenschaften

Länge	L	120
Außengewinde kegelig	R	1¼
Länge	L	120 mm
Gewicht	490,5 g	
Volumen	414,4 cm ³	
Werkstoff	Rotguss oder Siliziumbronze	