

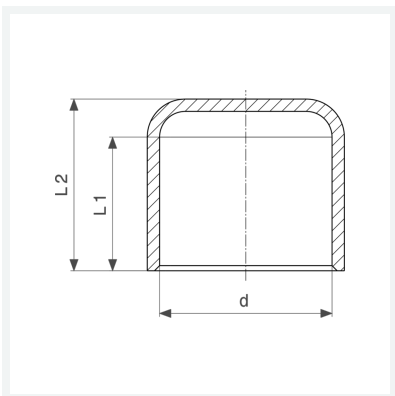

**Kappe**  
- Lötanschluss  
**Modell 95301**

**Artikel 109 134**



## Eigenschaften

Rohraußendurchmesser	d	35
Länge 1	L1	25 mm
Länge 2	L2	29 mm
Gewicht	49,2 g	
Volumen	82,88 cm <sup>3</sup>	
Werkstoff	Kupfer	