



Temponox-Schiebemuffe mit SC-Contur

- Pressanschlüsse

Ausstattung

Dichtelemente EPDM

Modell 1715.5

Artikel 809 201

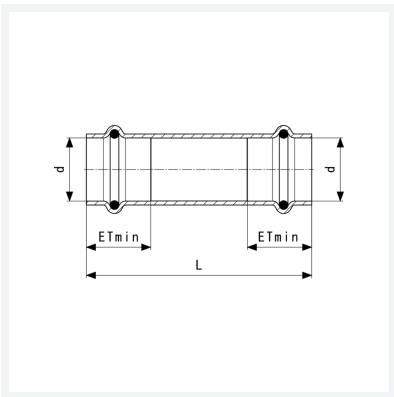

Eigenschaften

Rohraußendurchmesser	d	18
Einstecktiefe minimal	ETmin	22 mm
Länge	L	81 mm
Gewicht	56,5 g	
Volumen	124,32 cm ³	
Werkstoff	Stahl nichtrostend	