

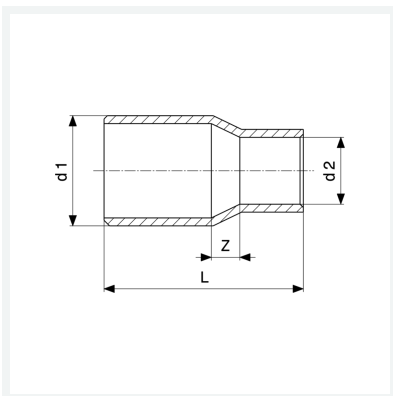

Reduzierstück
- Einsteckende, Lötanschluss
Modell 95243

Artikel 115 180



Eigenschaften

Gütesicherung Cu	Cu	✓
Rohraußendurchmesser 1	d1	35a
Rohraußendurchmesser 2	d2	18
Z-Maß	Z	9 mm
Länge	L	47 mm
Gewicht	60 g	
Volumen	82,88 cm ³	
Werkstoff	Kupfer	