











36 712 892



- Ausladung 190 mm
- starrer Auslauf
- runder luftangereicherter Strahl
- Bohrungsdurchmesser Seitenventil 40 mm
- Bohrungsdurchmesser Auslauf 40 mm
- Rosette Ø 55 mm
- Durchfluss max. 7 l/min
- bleifrei
- Dieses Produkt leistet einen Beitrag zur Erfüllung der Vorgaben von nachhaltigen Gebäudezertifizierungen, z.B. LEED®, BREEAM®, DGNB

	Chrom	36 712 892-00
	Platin gebürstet	36 712 892-06
	Platin	36 712 892-08
	Dark Chrome	36 712 892-19
	Light Gold gebürstet	36 712 892-27
	Messing gebürstet (23kt Gold)	36 712 892-28
	Schwarz matt	36 712 892-33
	Bronze gebürstet	36 712 892-42
	Champagne gebürstet (22kt Gold)	36 712 892-46
	Champagne (22kt Gold)	36 712 892-47
	Chrom gebürstet	36 712 892-93
	Dark Platinum gebürstet	36 712 892-99

**Benötigtes Zubehör**



- UP-Wandbatterie Auslauf mittig -** 35 700 970 90
- Max. Einbautiefe 145 mm
  - Min. Einbautiefe 85 mm

**Benötigtes Zubehör**



- UP-Wandbatterie variable Positionierung -** 35 720 970 90
- Max. Einbautiefe 145 mm
  - Min. Einbautiefe 85 mm

36 712 892

mm [inches]

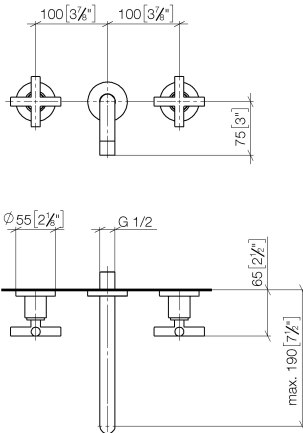

Durchflussdiagramm

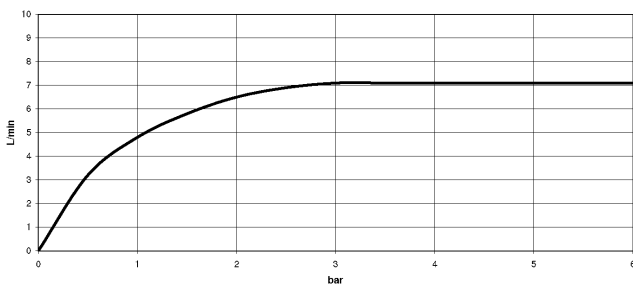

Codes & Standards

DIN 4109	EN 200	ISO 3822	Scottish Water Byelaws
UK Water Supply Regulations	Ü-Zeichen	VA-Zeichen	XP P 41-280



TARA Waschtisch-Wandbatterie ohne Ablaufgarnitur - Chrom

TARA

36 712 892

Zertifikate

ACS\_20 ACC LY

ETA\_19

WRAS\_2107

LGA\_18

36 712 892

Produktversion ab 4/1/2024

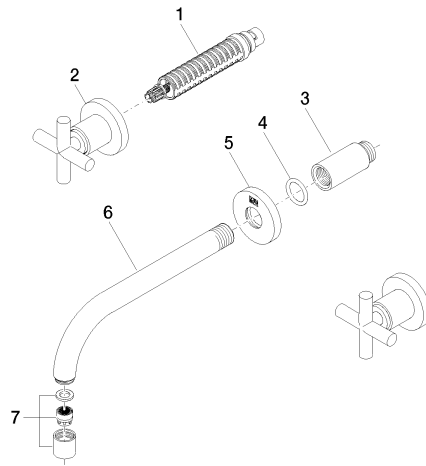



# TARA Waschtisch-Wandbatterie ohne Ablaufgarnitur - Chrom

TARA

36 712 892

## Ersatzteilstückliste

### Produktversion ab 4/1/2024

Nr.	Artikelnummer	Benennung	Verbaumenge	Lieferzeit
	90 90 03 157 00 90	Oberteil rechtsschließend 1/2" -	9	2