

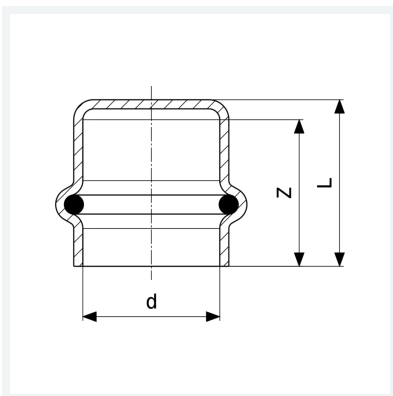

**Profipress-Kappe
mit SC-Contur**
- Pressanschluss
Ausstattung
Dichtelement EPDM
Modell 2456

Artikel 349 295



Eigenschaften

Rohraußendurchmesser	d	12
Z-Maß	Z	20 mm
Länge	L	23 mm
Gewicht	15,3 g	
Volumen	31,08 cm ³	
Werkstoff	Kupfer	