



Temponox-Bogen 45° mit SC-Contur

- Pressanschlüsse

Ausstattung

Dichtelemente EPDM

Modell 1726

Artikel 809 874

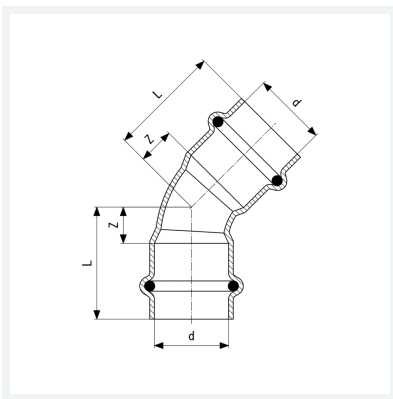

Eigenschaften

Rohraußendurchmesser	d	28
Z-Maß	Z	14 mm
Länge	L	38 mm
Gewicht	88 g	
Volumen	155,4 cm ³	
Werkstoff	Stahl nichtrostend	