



Profipress-Reduziermuffe mit SC-Contur

- Pressanschlüsse

Ausstattung

Dichtelemente EPDM

Modell 2415.2

Artikel 325 800

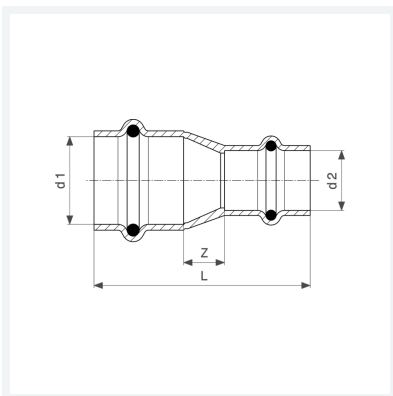

Eigenschaften

Rohraußendurchmesser 1	d1	22
Rohraußendurchmesser 2	d2	18
Z-Maß	Z	9 mm
Länge	L	54 mm
Gewicht	56,2 g	
Volumen	77,7 cm ³	
Werkstoff	Kupfer	