



## Profipress G-Schiebemuffe mit SC-Contur

- Pressanschlüsse

### Ausstattung

Dichtelemente HNBR

**Modell 2615.5**

**Artikel 394 219**

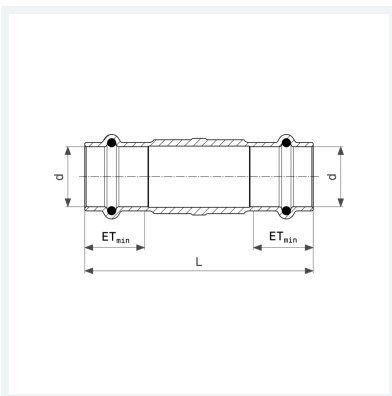

## Eigenschaften

Rohraußendurchmesser	d	42
Länge	L	120 mm
Einstecktiefe minimal	ETmin	36 mm
Gewicht	399,5 g	
Volumen	828,8 cm <sup>3</sup>	
Werkstoff	Rotguss	