

DE Montageanleitung

NL Montagehandleiding

EN Mounting instruction

CS Návod k instalaci

ES Instrucciones de instalación

PL Instrukcja montażu

FR Instructions d'installation

RU Инструкция по монтажу

IT Istruzioni per l'installazione

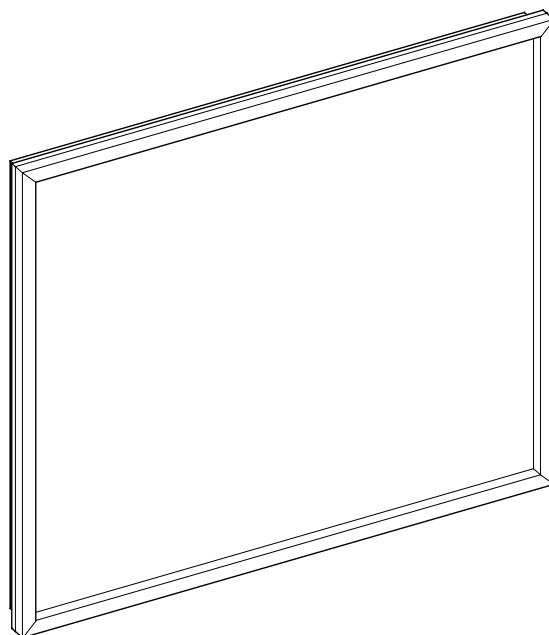

19095 012500

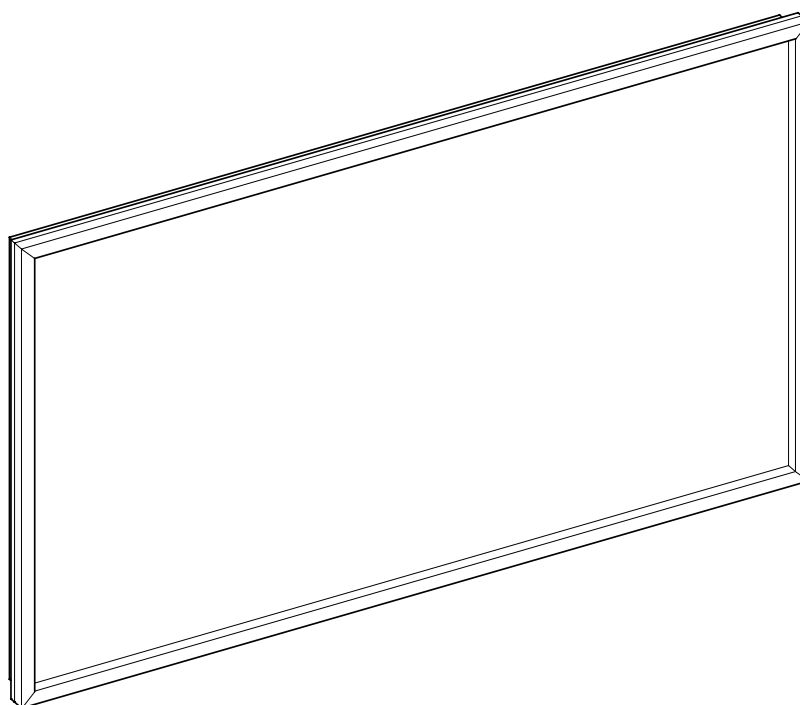

19095 013500

DE Einbaumaße

FR Cotes de montage

CS Montážní rozměry

EN Mounting dimensions

IT Ingombro

PL Wymiary montażowe

ES Dimensiones de montaje

NL Montageafmetingen

RU Монтажные размеры

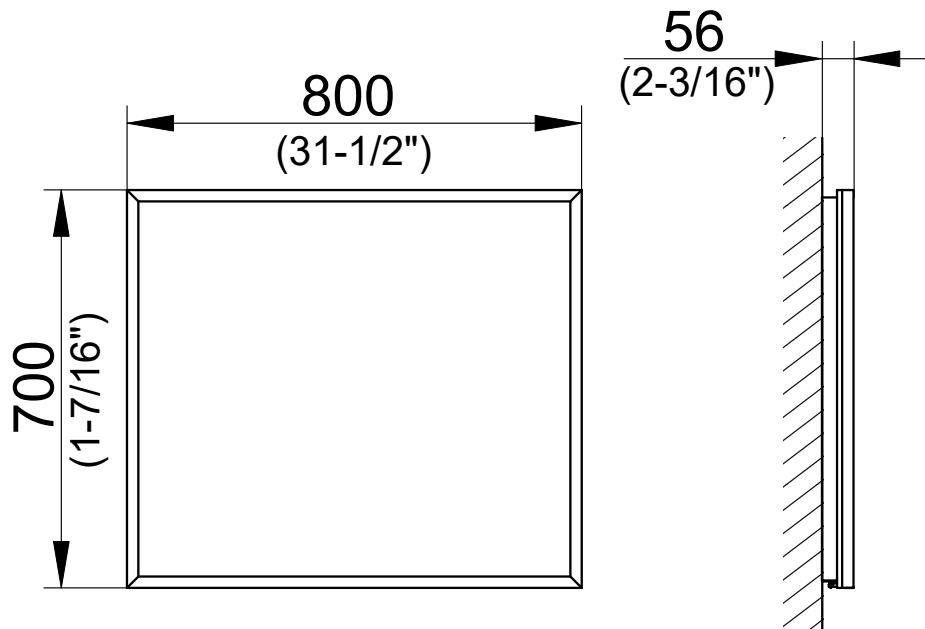

19095 012500

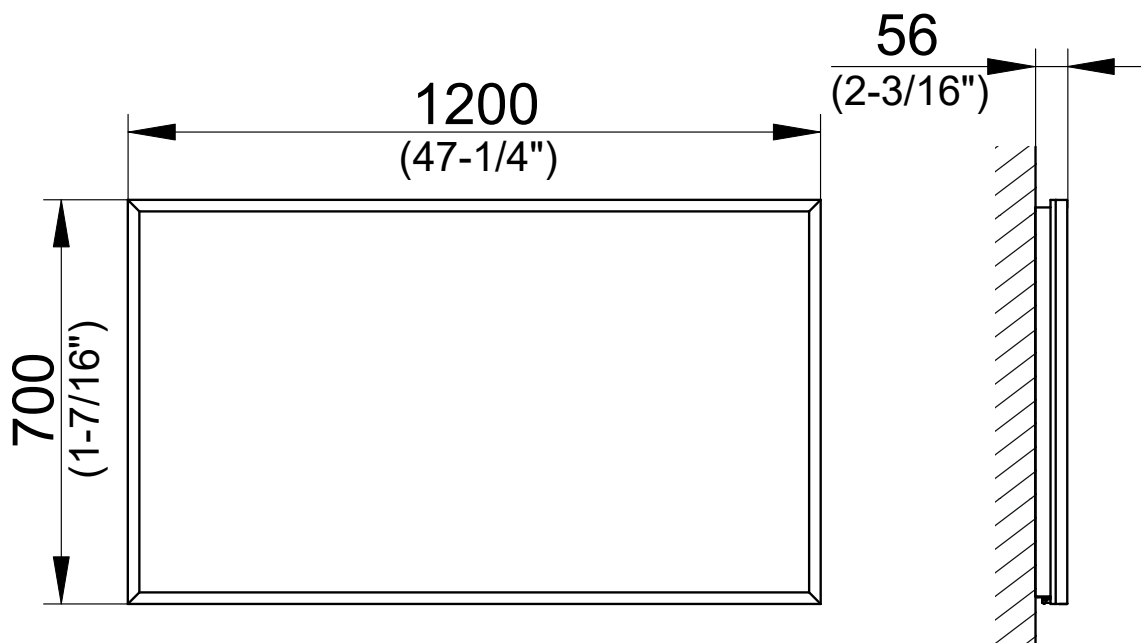



19095 013500

 Diese Anleitung ist für den Installateur zur Montage sowie für den Nutzer zur Bedienung und Wartung des Produktes. Bitte nach der Installation an den Nutzer zur Verwahrung weitergeben.

 These instructions are designed for the installation engineer to assemble the product and for the user to operate and maintain it. After installation, please pass them on to the user for safekeeping.

Symbole und Bedeutung

 **Achtung!** Warnung vor Personen- oder Sachschaden.

 **Achtung!** Warnung vor Stromschlag.

 **Achtung!** Warnung vor Wasserschaden.

 Hinweis, Tipp oder Verweis

 Korrekte Montage/Funktionsprüfung

 Falsche Montage

 Montagedetail beachten

 Optional/Zubehör

Symbols and their meaning

 **Caution!** Warning of personal injury or material damage

 **Caution!** Warning of electric shock.

 **Caution!** Warning of water damage.

 Note, tip or reference

 Correct assembly/functional test

 Incorrect assembly

 Observe assembly details

 Optional/accessories

Sicherheitsinformationen

 Es muss sichergestellt sein, dass die Wand das Gewicht des Spiegels tragen kann.

 Zur Vermeidung von Personen- und Sachschäden muss die Montage von zwei Personen durchgeführt werden.

Safety Information

 It must be ensured that the wall can support the weight of the mirror.

 To prevent personal injury or material damage the assembly must be carried out by two persons.

Verwendungszweck

 Produkt ausschließlich zur Montage in Innenräumen geeignet!

 **Achtung!** Installation nur in frostfreien Räumen.

Intended use

 The product is suitable only for mounting indoors!

 **Caution!** Only install in frost-free rooms.

Einbaumaße, siehe Seite 2.

Installation, siehe ab Bild 1 auf Seite 8.

Ersatzteile mit Bestellnummern, siehe Seite 11.

 Hinweise zur Gewährleistung und Pflege sind dem beiliegendem **Pflege- und Garantiepass** zu entnehmen.

Mounting dimensions, see page 2.









Installation, see figure 1 onwards on page 8.

Replacement parts with order numbers, see page 11.

 For information about warranty and maintenance, see the enclosed **Maintenance and Warranty Passport**.

 Este manual está destinado al instalador para el montaje, así al usuario para el manejo y mantenimiento del producto. Por favor, después de la instalación este manual se debe entregar al usuario para que lo conserve.

Símbolos y significado



-  **¡Atención!** Advertencia de daños personales o materiales.
-  **¡Atención!** Advertencia de descarga eléctrica.
-  **¡Atención!** Advertencia de daños a causa del agua.
-  Indicación, consejo o referencia
-  Montaje correcto/Comprobación de funcionamiento
-  Montaje erróneo
-  Observar el detalle de montaje
-  Opcional/Accesorios

Informaciones de seguridad

 Tiene que estar asegurado, que la pared puede soportar el peso del espejo.

 Para evitar daños personales y materiales el montaje tiene que ser llevado a cabo con dos personas.

Finalidad de uso

-  ¡Producto exclusivamente para el montaje en interiores!
-  **¡Atención!** Instalación exclusivamente en espacios sin hielo.

Medidas de montaje, véase página 2.









Instalación, véase imagen 1 en la página 8.

Piezas de recambio con números de pedido, véase página 11.

 En el **pasaporte de cuidado y garantía** adjunto encontrará indicaciones sobre la garantía y el cuidado.

 Ces instructions sont destinées à l'installateur, pour effectuer le montage, et à l'utilisateur, pour utiliser le produit et procéder à sa maintenance. Après l'installation, veuillez remettre ces instructions à l'utilisateur pour qu'il les conserve.

Symboles et leur signification



-  **Attention !** Mise en garde contre les dégâts de personnes et les dégâts matériels.
-  **Attention !** Mise en garde contre les chocs électriques.
-  **Attention !** Mise en garde contre les endommagements par l'eau.
-  Remarque, conseil ou renvoi
-  Montage correct/contrôle fonctionnel
-  Montage incorrect
-  Respecter le détail de montage
-  Option/accessoires

Informations en matière de sécurité

 Il convient de s'assurer que le mur peut supporter le poids du miroir.

 Pour éviter les dégâts de personnes et les dégâts matériels, le montage doit être effectué par deux personnes.

Domaine d'utilisation

-  Le produit ne convient que pour un montage à l'intérieur !
-  **Attention !** Installation uniquement dans des pièces à l'abri du gel.

Côtes d'encombrement, voir page 2.

Installation, voir à partir de la figure 1, à la page 8.

Pièces de rechange avec numéros de commande, voir page 11.

 Les consignes relatives à la garantie et à l'entretien figurent sur la **carte d'entretien et de garantie** jointe.

 Il presente manuale è indirizzato agli installatori per il montaggio nonché agli utilizzatori per l'uso e la manutenzione del prodotto. Consegnarlo all'utilizzatore dopo l'installazione affinché lo custodisca.

Simboli e significato

 **Attenzione!** Pericolo di lesioni o danni materiali.

 **Attenzione!** Pericolo di folgorazione.

 **Attenzione!** Pericolo di danni causati dall'acqua.

 Avvertenza, consiglio o rimando

 Montaggio corretto/verifica del funzionamento

 Montaggio errato

 Prestare attenzione al dettaglio di montaggio

 Opzionale/accessorio

Informazioni di sicurezza

 Deve essere garantito che la parete possa supportare il peso dello specchio.

 Al fine di evitare lesioni e danni materiali il montaggio deve essere eseguito da due persone.

Scopo d'uso

 Prodotto adatto esclusivamente per il montaggio in ambienti interni!

 **Attenzione!** Installazione solo in ambienti in assenza di gelo.

Dimensioni di montaggio, vedi pagine 2.

Installazione, vedi dalla figura 1 a pagina 8.

Ricambi con numero d'ordine, vedi pagina 11.

 Indicazioni relative alla garanzia e al trattamento vanno desunte dalla **relativa scheda**.

 Deze handleiding is zowel voor de installatiemonteur, als voor de gebruiker voor de bediening en het onderhoud van het product bedoeld. Geef de handleiding na de installatie aan de gebruiker om te bewaren.

Symbolen en betekenis

 **Opgepast!** Waarschuwing voor lichamelijke en materiële schade.

 **Opgepast!** Waarschuwing voor elektrische schokken.

 **Opgepast!** Waarschuwing voor waterschade.

 Aanwijzing, tip of verwijzing

 Controle van correcte montage/werking

 Verkeerde montage

 Montagedetail respecteren

 Optioneel/accessoire

Veiligheidsinformatie

 Er moet worden gecontroleerd of de wand het gewicht van de spiegel kan dragen.

 Om schade aan personen of zaken te vermijden moet de montage door twee personen worden uitgevoerd.

Beoogd gebruik

 Het product is uitsluitend voor montage in binnenruimten geschikt!

 **Opgepast!** Installatie alleen in vorstvrije ruimten.

Inbouwafmetingen, zie pagina 2.









Installatie, zie vanaf afbeelding 1 op pagina 8.

Wisselstukken met bestelnummers, zie pagina 11.



 Aanwijzingen over de garantie en het onderhoud kunnen op het bijgevoegde **Onderhouds- en garantiefblad** worden bekeken.

 Tento návod slouží instalatérům při montáži a uživatelům při obsluze a údržbě produktu. Po nainstalování ho předejte uživateli, aby si ho mohl uschovat.



Symbole a jejich význam

-  **Pozor!** Výstraha před zraněním a materiálními škodami.
-  **Pozor!** Výstraha před úrazem elektrickým proudem.
-  **Pozor!** Výstraha před poškozením vodou.
-  Upozornění, tip nebo odkaz
-  Správná montáž / kontrola funkčnosti
-  Nesprávná montáž
-  Při montáži dbejte na tento detail
-  Volitelná výbava / příslušenství

Informace o bezpečnosti

-  Je nutné zajistit, aby stěna unesla hmotnost zrcadlové skříňě.
-  Aby se zabránilo zraněním a materiálním škodám, musí montáž provádět dvě osoby.

Účel použití

-  Výrobek je vhodný výhradně k montáži ve vnitřních prostorech!
-  **Pozor!** Instalace v prostorech, které nepromrzají.

Montážní rozměry viz straně 2.









Instalace viz obr. 1 na straně 8.

Náhradní díly s objednáacími čísly viz straně 11.



 Pokyny týkající se záruky a péče najdete v příloženém **Návodu k údržbě a záručním listu**.

 Instrukcja przeznaczona jest dla instalatora, zapewniając pomoc w zakresie montażu oraz dla użytkownika, informując go o sposobie obsługi i konserwacji produktu. Po instalacji należy przekazać instrukcję użytkownikowi, aby ją u siebie przechowywał.



Symbole i znaczenie

-  **Uwaga!** Ostrzeżenie przed szkodami osobowymi i materialnymi.
-  **Uwaga!** Ostrzeżenie przed porażeniem prądem elektrycznym.
-  **Uwaga!** Ostrzeżenie przed szkodami, spowodowanymi przez wodę.
-  Informacja, dobra rada lub odsylacz
-  Właściwy montaż/kontrola funkcjonowania
-  Niewłaściwy montaż
-  Należy stosować się do danych, dotyczących montażu
-  Opcje/Osprzęt

Informacje dotyczące bezpieczeństwa

-  Należy upewnić się, że ściana jest w stanie unieść ciężar lustra.
-  W celu uniknięcia szkód osobowych i materialnych montaż powinny wykonywać dwie osoby.

Przeznaczenie

-  Produkt przeznaczony jest wyłącznie do montażu wewnątrz budynków!
-  **Uwaga!** Instalacja wyłącznie w pomieszczeniach, w których temperatura nie spada poniżej zera.

3Wymiary zabudowy, patrz stronie 2.

Instalacja, patrz rys. 1 na stronie 8 i dalsze.

Części zamiennie z numerami zamówienia, patrz stronie 11.

 Informacje dotyczące gwarancji dostępne są w dołączonej **karcie pielęgnacyjno-gwarancyjnej**.

1

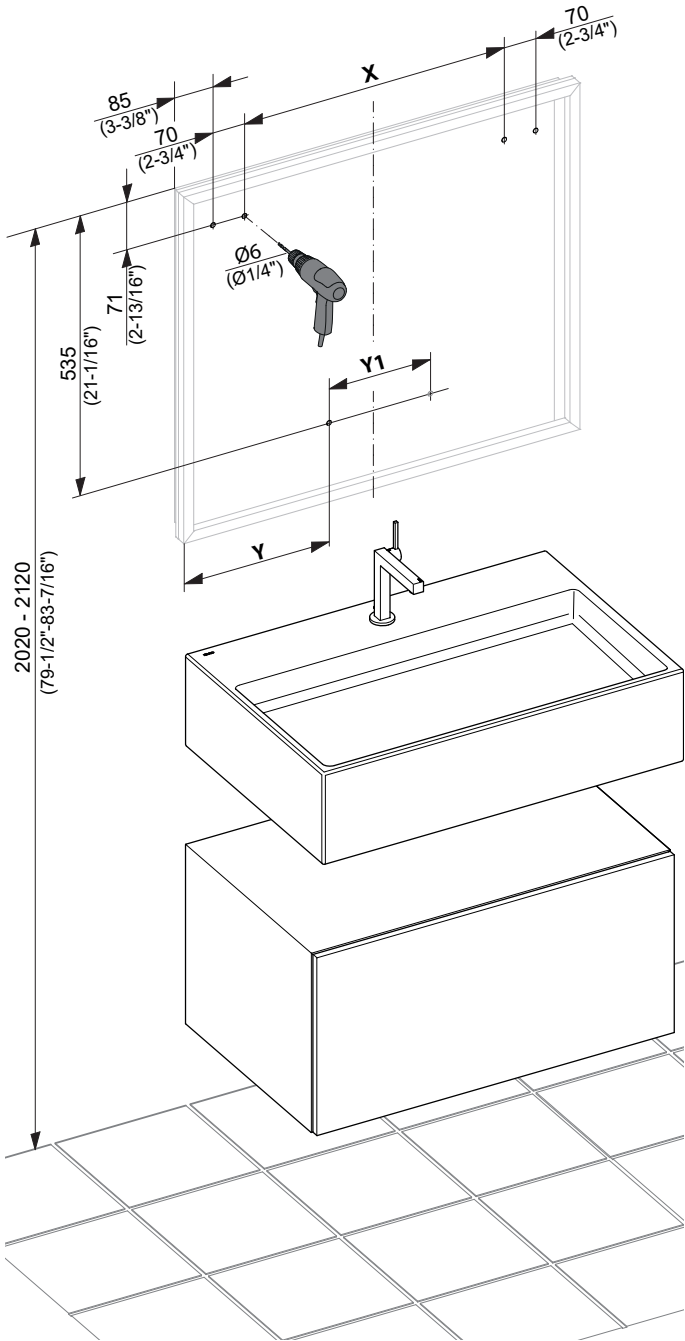
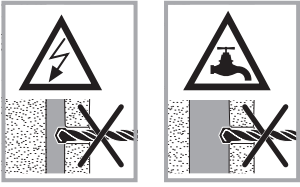

2

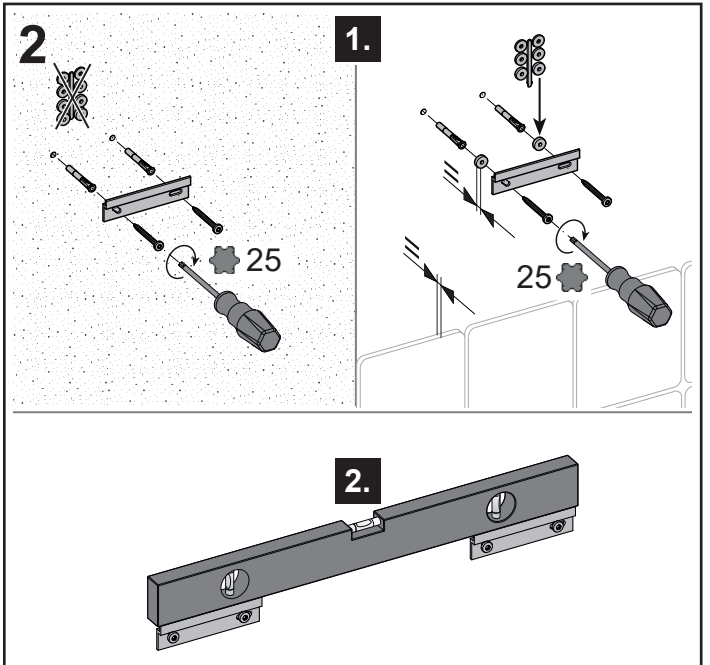

3

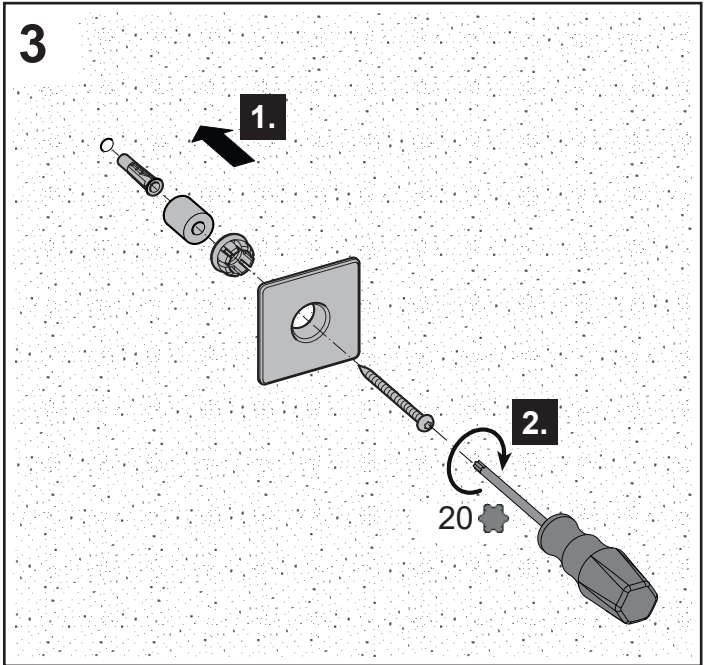

4

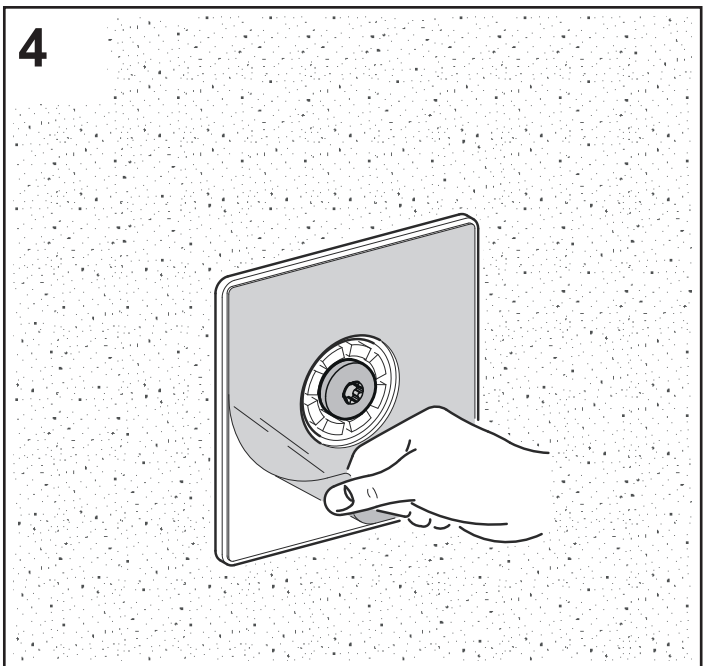

19095	012500	013500
X	490 (19-5/16")	890 (35-1/16")
Y	530 (20-7/8")	275 (10-13/16")
Y1	---	650 (25-9/16")

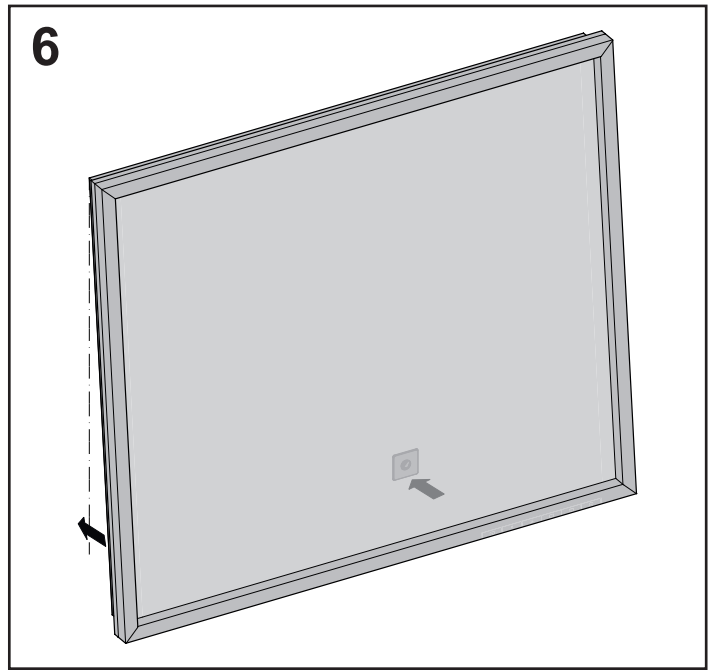
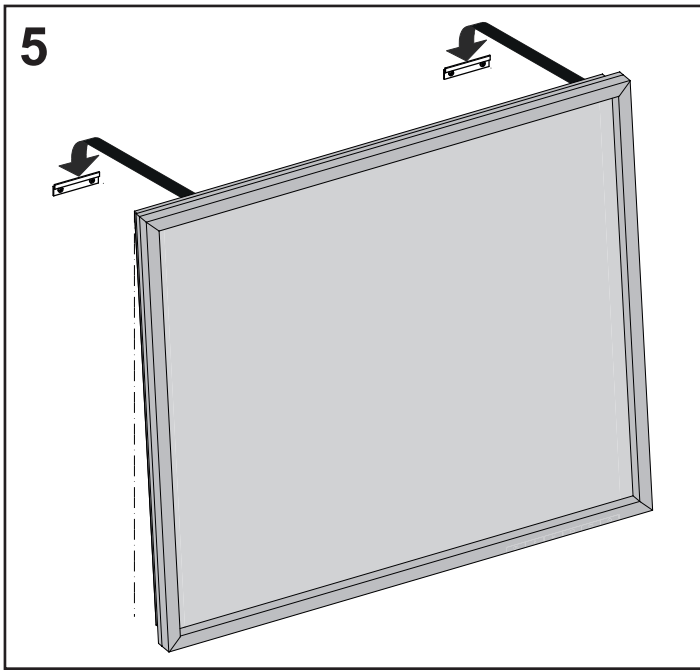



A series of 20 horizontal lines for writing, spaced evenly down the page.

DE Ersatzteile

FR Liste de pièces

CS Náhradní díly

EN Spare parts

IT Ricambi

PL Części zamienne

ES Piezas de recambio

NL Reserveonderdelen

RU Запчасти

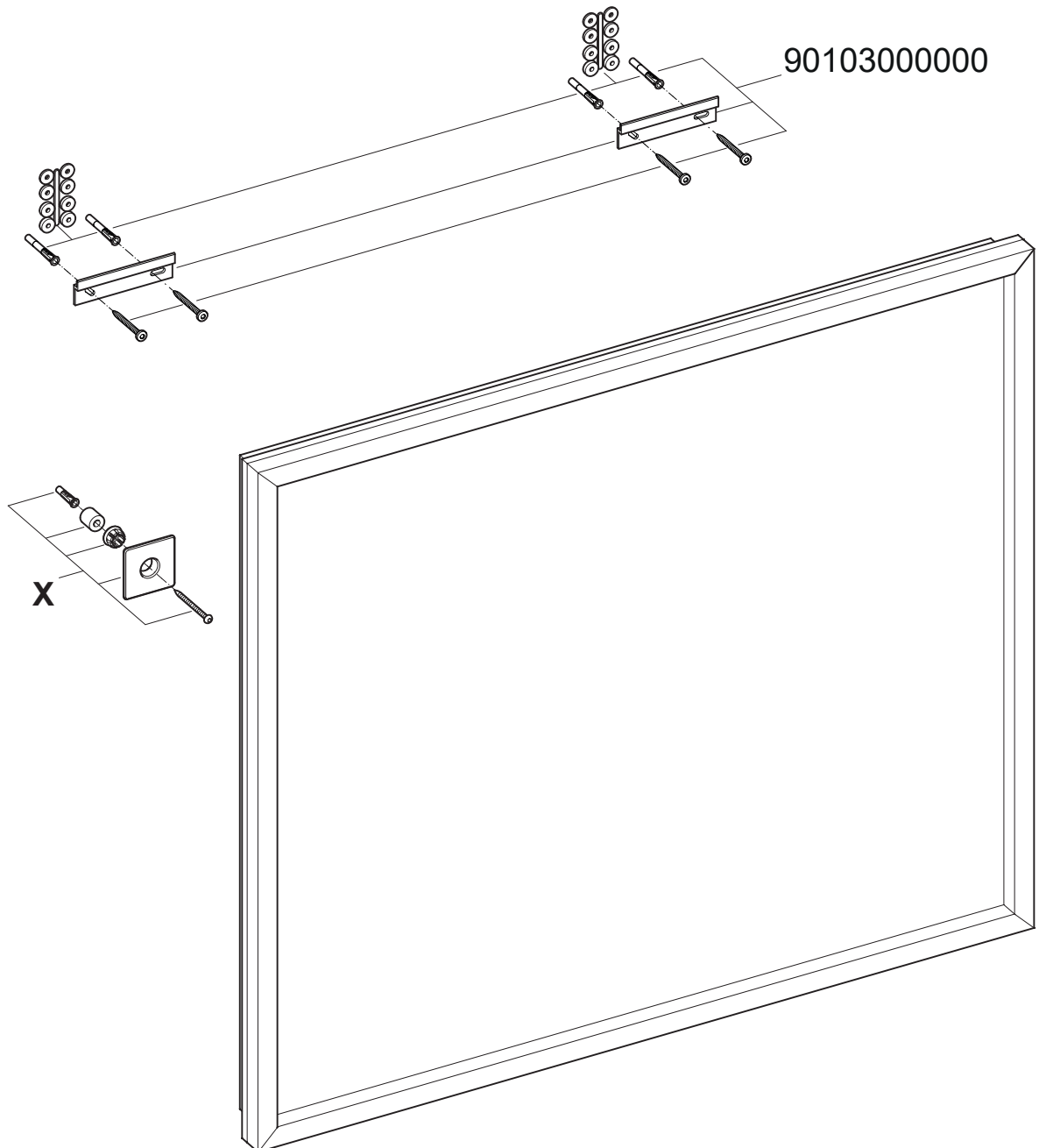

19095

012500

013500

X

9010300008

9010300011

