

X-Line

33122110001 Waschtischunterbau

**PRODUKT**



**ZEICHNUNG**

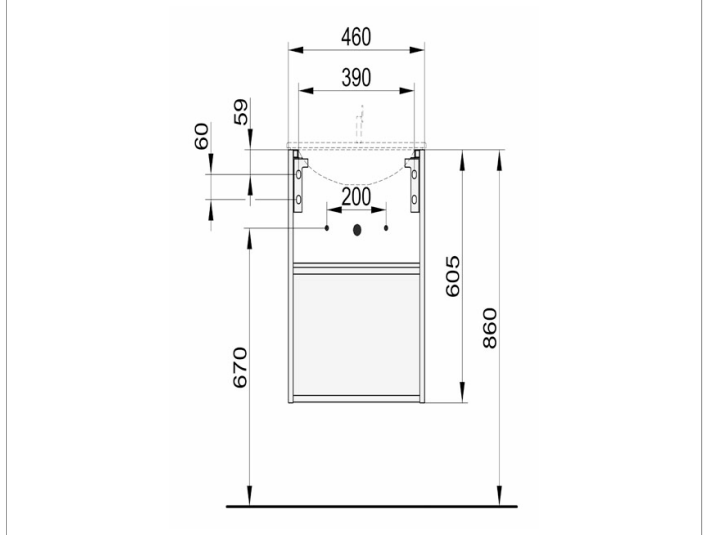

**OBERFLÄCHE**

anthrazit/anthrazit

**ABMESSUNG**

460 x 605 x 380 mm