

X-Line

33122300001 Waschtischunterbau

PRODUKT



ZEICHNUNG

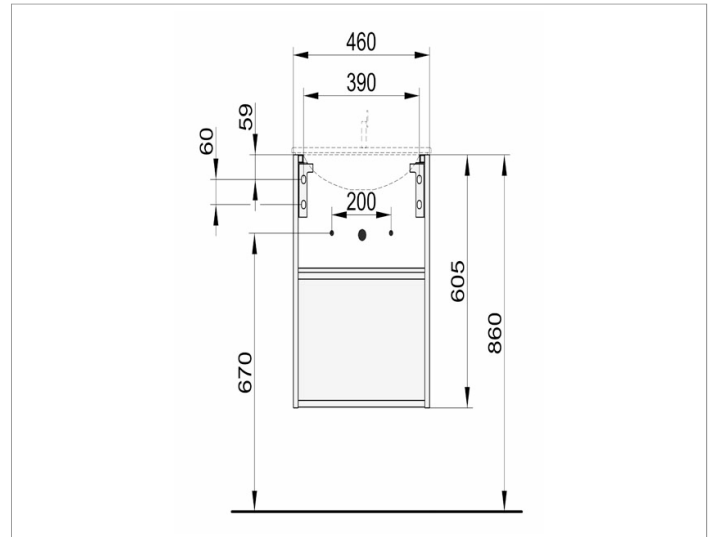

OBERFLÄCHE

weiß/weiß

ABMESSUNG

460 x 605 x 380 mm